



# Product Catalogue

1st Edition  
2025



# RELIABLE TOOLS FOR RELIABLE REPAIRS



A high-tech company specializing in the development & production of automotive maintenance and diagnostic products

**AUTOOL**<sup>®</sup>

RELIABLE TOOLS FOR  
RELIABLE REPAIRS



Founded in  
2014



3-year  
warranty



Workforce of  
Over 250  
Employees



60 Research &  
Development  
Engineers



15 Quality  
Control Experts

**18,000**

18,000 m<sup>2</sup> of  
production base

**160**

Boasting sales in over  
160 countries & regions

**2,000,000**

Over 2,000,000  
worldwide users

# OUR STORY

AUTOOL was founded in 2014 and is headquartered in Shenzhen, China. It is a high-tech company specializing in the development and production of automotive maintenance and diagnostic products. Over the years, through the successive release of a series of products and the ongoing improvement of quality and service, AUTOOL has progressively become a familiar and highly regarded presence in the automotive industry.

AUTOOL always selects long-lasting and durable product materials, adheres to the production process of excellence, and upholds the spirit of revolution and innovation, committing to creating products with innovative and superior quality for users. We AUTOOL would like to extend a warm invitation to you in casting the legendary brand together and begin our story.

In the present day, AUTOOL has expanded its presence to 160 countries worldwide. AUTOOL will offer infinite possibilities, differentiated by its branding colors, warm yellow and mysterious black. There is always an option for you, which you will find user-friendly and advantageous.

#### OUR PHILOSOPHY:

We will always stand behind our products, be responsible for our customers, and be reliable for our partners.

#### OUR VALUES:

No complaints, never give up, mutual support and mutual success.

#### OUR VISION:

We aspire to deliver automotive users worldwide with exceptionally professional, efficient, and steadfast maintenance solutions.





# CONTENTS

## AUTOMOTIVE REPAIR & TESTING EQUIPMENT

Battery System Tester	04-07
Fuel Injector Cleaner & Tester	08-12
Smoke Leak Detector	13-17
Smart Articulating Borescope	18-23
Auto Diagnostic Multimeter	24-26
3D Wheel Aligner Machine	27-29

## AUTOMOTIVE REPAIR & MAINTENANCE EQUIPMENT

Walnut Shell Blasting Machine	30-33
Dry Ice Blasting Machine	34-36
Pulsating Brake Fluid Exchanger	37-40
Automotive Stabilized Power Supply	41-44
Transmission Fluid Exchanger	45-47
Cooling System Tester & Filler	48-50
Smart Digital Manifold Gauge	51-54
Refrigerant Recovery Machine	55-57

## MAINTENANCE TOOL STORAGE SERIES

Automotive Service Cart	59
Rolling Utility Cart	60-61
Service Tool Storage Cabinet	62







**AUTOOL**

RELIABLE TOOLS FOR  
RELIABLE REPAIRS



# BATTERY SYSTEM TESTER

Utilizing cutting-edge conductivity testing technology, the AUTOOL Battery System Tester swiftly and precisely assesses critical parameters such as actual cold start current, battery voltage, state of charge (SOC), and state of health (SOH) percentage, providing comprehensive insights into battery performance and longevity.

BT460

05

BT760

06

BT960

07





# BATTERY SYSTEM TESTER

Utilizing cutting-edge conductivity testing technology, the AUTOL BT460 Battery System Tester can accurately display the battery's current actual cold cranking amperage (CCA), battery voltage, state of charge (SOC), and state of health percentage (SOH) through rapid measurement.

Four Major Testing Functions: Battery test, cranking test, charging test, and load test. The cranking test and charging test can display the voltage waveform graph.

Clear Interface for Easy Viewing: HD 2.8-inch TFT color display with wide viewing angles.

Detect Multiple Battery Data: Battery life, voltage, internal resistance, battery charge level, battery starting status, and battery load status, charging status.

High Practicality with Broad Range: Voltage testing range of 8-30V; supports testing of various battery types (standard lead-acid, AGM flat plate, AGM spiral, GEL, EFB) suitable for motorcycles, trucks, cars, and electric two-wheelers in various sizes.

Comprehensive Upgrade with Strong Compatibility: One device compatible with battery testing standards (CCA, DIN, IEC, EN, GB, JIS).

Smart Overheat Protection and Reverse Polarity Protection: Automatically cuts off power in case of short circuits during operation to prevent device damage.



Battery Test



Cranking Test



Charging Test



Load Test



Reverse Polarity Protection



Multi-language

## APPLICATIONS

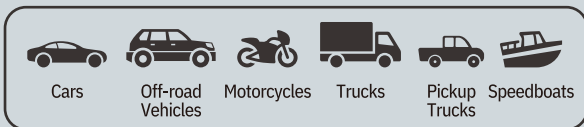

Suitable for 12V/24V Batteries:



Applicable Battery Types:



Select Standard
CCA (USA)
IEC (International)
EN (EUROPE)
DIN (Germany)
JIS (Japan)

Battery Test	
SOC	90%
Life	100%
Voltage	12.54V
Current	675 A(CCA)
Resistance	4.01 mΩ
Good	

Language Selection
English
Português
Español
Francais
Deutsch
Italiano

Voltage Testing Range	8-30V
Testing Standards Range	30-2000 CCA
Operating Temperature	-20°C-50°C
Screen Size	2.8-inch Color Display Screen
Main Unit Dimensions	150x80x30mm



# BATTERY SYSTEM TESTER



BT760

BATTERY SYSTEM TESTER

Utilizing advanced conductivity testing technology, the AUTOOL BT760 Battery System Tester can accurately display the battery's current cold cranking amperage (CCA), battery voltage, state of charge (SOC), and state of health percentage (SOH) through rapid measurement.

Four Testing Functions: Battery Test, Cranking Test, Charging Test, Load Test.

Clear Interface, Easy to Read: High-definition 3.2-inch TFT color display screen with a wide viewing angle.

Detects Multiple Battery Data: Battery life, battery voltage, battery internal resistance, battery charge, battery starting status, battery load status.

Highly Practical, Wide Measurement Range: Voltage testing range of 8-30V, supports testing of (standard lead-acid batteries/AGM flat plate batteries/AGM spiral batteries/GEL batteries/EFB batteries), suitable for motorcycles, trucks, cars, and electric two-wheelers in various sizes.

Comprehensive Upgrade, Strong Compatibility: One device compatible with (CCA, DIN, IEC, EN, GB, JIS) battery testing standards.

Smart Overheat Protection and Reverse Polarity Protection: Automatically cuts off power in case of a short circuit during operation to prevent device damage.

Built-in Thermal Printing Function: Allows for setting license plates/date/number and real-time printing of test data.

Space-Saving, Compact and Portable: Comes with a tool bag for convenient storage and management of various parts.



Battery Test



Cranking Test



Charging Test



Load Test



Data Printing



Multi-language

Suitable for 12V/24V Batteries:



Applicable Battery Types:



## APPLICATIONS

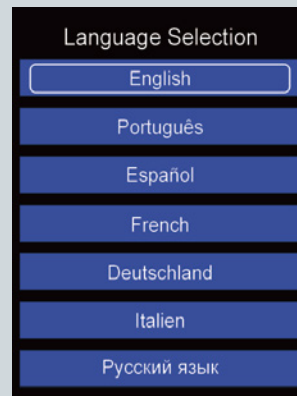
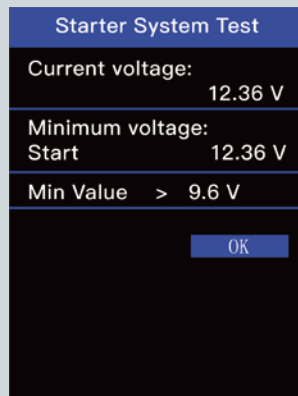
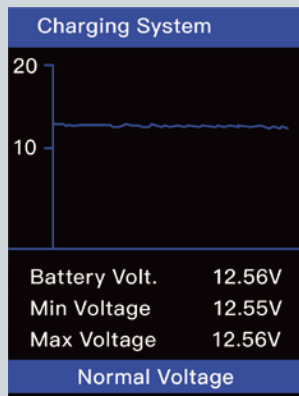
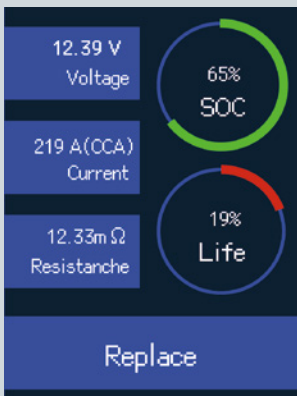

Voltage Testing Range	8-30V
Testing Standards Range	30-2000 CCA
Operating Temperature	-20°C-50°C
Screen Size	3.2-inch Color Display Screen
Main Unit Dimensions	210x98x38mm





# BT960

# BATTERY SYSTEM TESTER

Utilizing cutting-edge conductivity testing technology and voltmeter-ammeter measurement technology, the AUTOOL BT960 Battery System Tester supports lithium battery testing and can accurately display and print the battery's actual cold cranking amperage (CCA), voltage, state of charge (SOC), and state of health (SOH) percentage through rapid measurement. It can also monitor the real-time voltage and current of both lead-acid and lithium batteries, helping to determine whether there is any static leakage in the vehicle's electrical system.

AUTOOL

07

BT960

BATTERY SYSTEM TESTER

Professional Equipment with 7 Major Testing Functions: Lithium Battery Test, Lead-Acid Battery Test, Cranking Test, Charging Test, Load Test, Voltage Test, and Current Test.

Highly Practical with a Wide Measurement Range: Voltage testing range of 0-80V, supports testing of (lithium batteries/lead-acid batteries/AGM flat plate batteries/AGM spiral batteries/GEL batteries/EFB batteries), suitable for motorcycles, trucks, cars, and electric two-wheelers in various sizes.

Current Testing: Allows monitoring of battery leakage by observing changes in current.

Comprehensive Upgrade with Dual Testing Modes: Lithium Battery/Lead-Acid Battery multifunctional testing, compatible with (CCA, DIN, IEC, EN, GB, JIS) battery testing standards using a single device.

Smart Overheat Protection and Reverse Polarity Protection: Effectively prevents short circuits during operation by immediately cutting off power to avoid damage to the device.

Efficient and Reliable Use: Built-in thermal printing function for real-time printing of test data, with settings for license plates/date/number.

Clear Interface and Easy to Read: High-definition 3.2-inch TFT color display screen with a wide viewing angle.

Space-Saving, Compact and Portable: Comes with a tool bag for convenient storage and management of various parts.



Battery Test



Lithium Battery Test



Charging Test



Load Test



Voltage Test



Current Test

Suitable for 12V/24V Batteries:



Applicable Lithium Battery Types:



Applicable Battery Types:



## APPLICATIONS

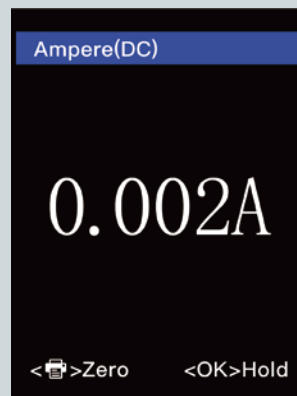
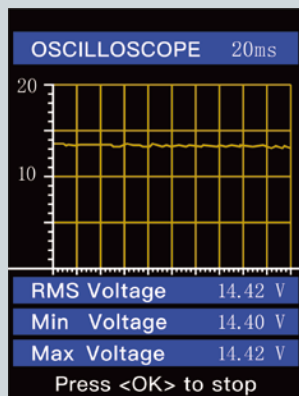
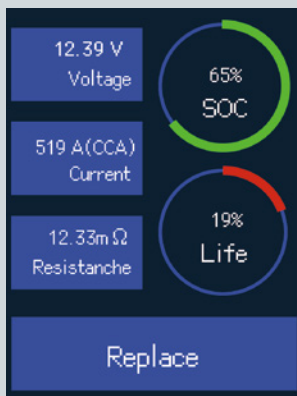
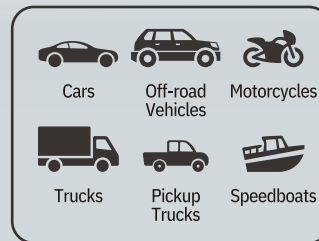

Voltage Testing Range	0-80V
Testing Standards Range	30-2000 CCA
Operating Temperature	-20°C-50°C
Screen Size	3.2-inch Color Display Screen
Main Unit Dimensions	210x98x38mm



# FUEL INJECTOR CLEANER & TESTER

The AUTOOL Fuel Injector Cleaner & Tester utilizes the latest ultrasonic cleaning and testing technology, supporting various types of fuel injectors such as GDI, EFI, and FSI. Whether it's forward or reverse flushing or leak detection, the AUTOOL Fuel Injector Cleaner & Tester enhances your work efficiency and testing accuracy.

The logo for AUTOOL, featuring the word "AUTOOL" in a bold, sans-serif font with a yellow underline, all contained within a white rectangular box.

RELIABLE TOOLS FOR  
RELIABLE REPAIRS

<b>FN602</b>	<b>09</b>
--------------	-----------

<b>FN603</b>	<b>10</b>
--------------	-----------

<b>FN606</b>	<b>11</b>
--------------	-----------

<b>FN608</b>	<b>12</b>
--------------	-----------





# FUEL INJECTOR CLEANER & TESTER (4-CYLINDER)

Specialist in Fuel Injector Cleaning and Testing with 13 Functions: Includes heated ultrasonic cleaning, idle speed test, medium speed test, high speed test, acceleration test, variable speed test, leakage test, idle injection volume test, medium-speed injection volume test, high-speed injection volume test, pulse injection test, reverse flushing, and no-disassembly cleaning.

**Cleaning/Testing Combo:** 100ml transparent glass cylinder for cleaning and testing up to 4 fuel injectors simultaneously.

**Operating Condition Simulation:** Simulates various engine operating conditions to clearly assess fuel injector atomization, spray volume, and sealing condition.

**Compatible with Various Injectors:** Supports 12V, 70V, and 120V voltage settings. It works with GDI, EFI, FSI injectors, and is also compatible with standard injectors.

**Smart Control Panel:** Intuitive interface for adjusting operation time, pulse width, and working pressure.

**Large Capacity Cleaning Tank:** 2000ml tank supports cleaning of fuel injectors for most motorcycles and cars on the market.

**Complete Accessories:** Includes different sizes of adapter fittings.

The AUTOOL FN602 Fuel Injector Cleaner & Tester utilizes the latest ultrasonic cleaning and testing technology, supporting various types of fuel injectors such as GDI, EFI, and FSI. Whether it's forward or reverse flushing or leak detection, the AUTOOL Fuel Injector Cleaner & Tester enhances your work efficiency and testing accuracy.



13 Functions Available



Sprayability Test



Spray Value Test



Heating The Cleaning Fluid



Reverse flushing



On-Vehicle Cleaning

## Various Connectors

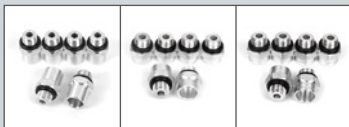

Ø 11mm    Ø 12mm    Ø 12.5mm



Ø 13mm    Ø 13.6mm    Ø 14mm



Ø 15mm    Ø 15.8mm    For BMW



No corrosive liquids



Prevent any leakage



No open flames



Wear eye protection



## Quick Guide

### ULTRASONIC CLEANING

– Pour the dedicated injector cleaning solution and connect the pulse signal line (A) to the injector.

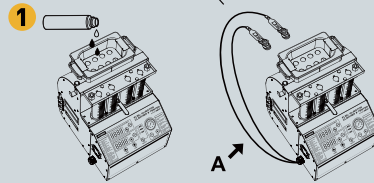

– Place the injector in the cleaning tank (B), select the ultrasonic cleaning function (C), and start the cleaning.

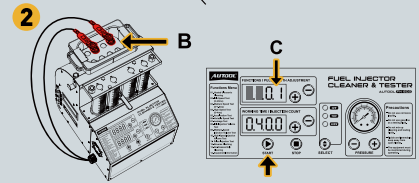

### FUEL INJECTOR TESTING

– Wear goggles first and then add in the dedicated test fluid.

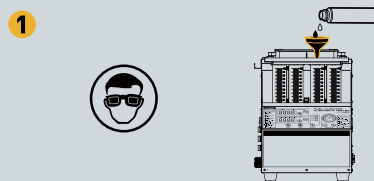

– Install the injectors onto the oil distributor (A), secure the distributor onto the main unit (B), and then start testing.

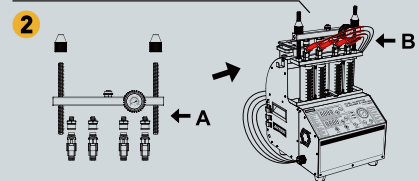

Power Supply	AC110V or AC220V	Supported Injector Types	GDI/EFI/FSI/Ordinary
Cleaning Tank Capacity	2000ml	System Pressure	0-0.55Mpa
Glass Tube Capacity	100ml	Time Setting	0-10min
Analog Speed Range	0-7500RPM	Ultrasonic Cleaning Frequency	28kHz
Times of Injections	0-9900 times	PWM Pulse Width	0-20ms



# FUEL INJECTOR CLEANER & TESTER (6-CYLINDER)

Specialist in Fuel Injector Cleaning and Testing with 13 Functions: Includes heated ultrasonic cleaning, idle speed test, medium speed test, high speed test, acceleration test, variable speed test, leakage test, idle injection volume test, medium-speed injection volume test, high-speed injection volume test, pulse injection test, reverse flushing, and no-disassembly cleaning.

Cleaning/Testing Combo: 110ml transparent glass cylinder, capable of cleaning and testing up to 6 injectors simultaneously.

The cleaning tank has a heating function, with a constant temperature of up to 50 degrees Celsius.

Compatible with Various Injectors: Supports 12V, 70V, and 120V voltage settings. It works with GDI, EFI, FSI injectors, and is also compatible with standard injectors.

Condition Simulation Testing: Simulates various engine operating conditions to clearly observe the injector's atomization, fuel injection volume, and sealing condition.

Smart Control Panel: Provides intuitive operation for adjusting working time, pulse width, and working pressure.

Large Capacity 3000ml Cleaning Tank: Suitable for cleaning injectors from most types of motorcycles and cars available on the market.

Portable Drawer Design: Includes a portable drawer at the bottom for easy storage and management of various adapters.

Comprehensive Configuration: Comes with 9 different sizes of adapter connectors.



13 Functions Available



Voltages Selection



Wide Compatibility



Smart Oil Pressure Control System



Heating The Cleaning Fluid



Practical Drawer Design

## Various Connectors



No corrosive liquids



Prevent any leakage



No open flames



Wear eye protection

The AUTOOL FN603 Fuel Injector Cleaner & Tester utilizes the latest ultrasonic cleaning and testing technology, supporting various types of fuel injectors such as GDI, EFI, and FSI. Whether it's forward or reverse flushing or leak detection, the AUTOOL Fuel Injector Cleaner & Tester enhances your work efficiency and testing accuracy.



FN603 FUEL INJECTOR CLEANER & TESTER

### Quick Guide

#### ULTRASONIC CLEANING

- Pour the dedicated injector cleaning solution and connect the pulse signal line (A) to the injector.
- Place the injector in the cleaning tank (B), select the ultrasonic cleaning function (C), and start the cleaning.

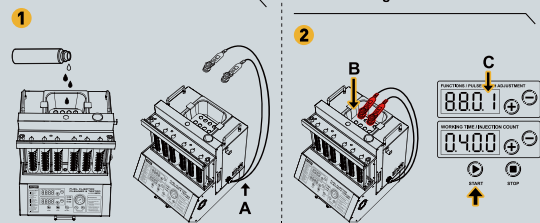

#### FUEL INJECTOR TESTING

- Wear goggles first and then add in the dedicated test fluid.
- Install the injectors onto the oil distributor (A), secure the distributor onto the main unit (B), and then start testing.

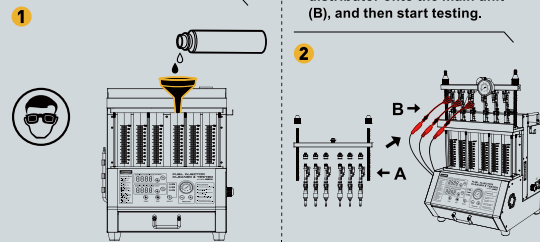

Power Supply	AC110V or AC220V	Supported Injector Types	GDI/EFI/FSI/Ordinary
Cleaning Tank Capacity	3000ml	System Pressure	0-0.55Mpa
Glass Tube Capacity	110ml	Time Setting	0-10min
Analog Speed Range	0-7500RPM	Ultrasonic Cleaning Frequency	28kHz
Times of Injections	0-9900 times	PWM Pulse Width	0-20ms





# FUEL INJECTOR CLEANER & TESTER (6-CYLINDER)

The AUTOOL FN606 Fuel Injector Cleaner & Tester utilizes the latest ultrasonic cleaning and testing technology, supporting various types of fuel injectors such as GDI, EFI, and FSI. Whether it's forward or reverse flushing or leak detection, the AUTOOL Fuel Injector Cleaner & Tester enhances your work efficiency and testing accuracy.

Specialist in Fuel Injector Cleaning and Testing with 15 Functions: Includes three new testing functions (Pulse Injection Test, Wide Pulse Injection Test, Continuous Injection Test).

Cleaning/Testing Combo: 110ml transparent glass cylinder, capable of cleaning and testing up to 6 injectors simultaneously.

The cleaning tank has a heating function, with a constant temperature of up to 50 degrees Celsius. Suitable for cleaning injectors from most types of motorcycles and cars available on the market.

Compatible with Various Injectors: Supports 12V, 12-70V, and 120V-180V voltage settings. It works with GDI, EFI, FSI injectors, and is also compatible with standard injectors.

Condition Simulation Testing: Simulates various engine operating conditions to clearly observe the injector's atomization, fuel injection volume, and sealing condition.

Smart Control Panel with High-Definition Color Display: Provides intuitive operation for adjusting working time, pulse width, and working pressure.

Portable Drawer Design: Includes a portable drawer at the bottom for easy storage and management of various adapters.

Comprehensive Configuration: Comes with 9 different sizes of adapter connectors and special connectors for BMW and Mercedes-Benz.

The cleaning tank can be used either in conjunction with the device or separately.



15 Functions Available



Voltages Selection



Wide Compatibility



Heating The Cleaning Fluid



Practical Drawer Design



Color Display Screen

## Various Connectors



Ø 11mm    Ø 12mm    Ø 12.5mm    Ø 13mm    Ø 13.6mm    Ø 14mm    Ø 15mm    Ø 15.8mm    For BMW

### Quick Guide

#### ULTRASONIC CLEANING

- Pour the dedicated injector cleaning solution.

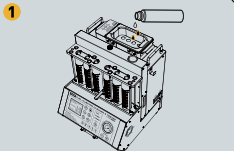

- Select the ultrasonic cleaning function 01 and press the confirm button (C) to input the pulse signal to the injector.

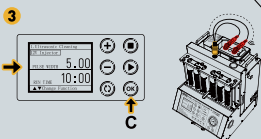

- Connect the injector with the pulse signal cable (A) and place it in the cleaning tank (B).

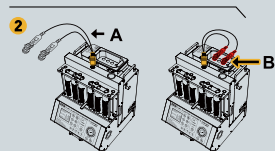

- Press the start button (D) on the ultrasonic cleaner panel to begin the process.

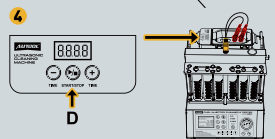

#### FUEL INJECTOR TESTING

- Wear goggles first and then add in the dedicated test fluid.

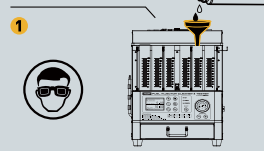

- Install the injectors onto the oil distributor (A), secure the distributor onto the main unit (B), and then start testing.

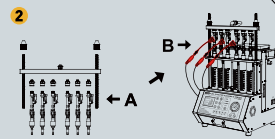

No corrosive liquids



Prevent any leakage



No open flames



Wear eye protection

Power Supply	AC110V or AC220V	Supported Injector Types	GDI/EFI/FSI/Ordinary
Cleaning Tank Capacity	550ml	System Pressure	0~0.8Mpa
Glass Tube Capacity	110ml	Time Setting	0-10min
Analog Speed Range	0~7500RPM	Ultrasonic Cleaning Frequency	28kHz
Times of Injections	0~9900 times	PWM Pulse Width	0~40ms



# FUEL INJECTOR CLEANER & TESTER (8-CYLINDER)

The AUTOOL FN608 Fuel Injector Cleaner & Tester utilizes the latest ultrasonic cleaning and testing technology, supporting various types of fuel injectors such as GDI, EFI, and FSI. Whether it's forward or reverse flushing or leak detection, the AUTOOL Fuel Injector Cleaner & Tester enhances your work efficiency and testing accuracy.



Specialist in Fuel Injector Cleaning and Testing with 15 Functions: Includes three new testing functions (Pulse Injection Test, Wide Pulse Injection Test, Continuous Injection Test).

Cleaning/Testing Combo: 110ml transparent glass cylinder, capable of cleaning and testing up to 8 injectors simultaneously.

The cleaning tank has a heating function, with a constant temperature of up to 50 degrees Celsius. Suitable for cleaning injectors from most types of motorcycles and cars available on the market.

Compatible with Various Injectors: Supports 12V, 12-70V, and 120V-180V voltage settings. It works with GDI, EFI, FSI injectors, and is also compatible with standard injectors.

Condition Simulation Testing: Simulates various engine operating conditions to clearly observe the injector's atomization, fuel injection volume, and sealing condition.

Smart Control Panel with High-Definition Color Display: Provides intuitive operation for adjusting working time, pulse width, and working pressure.

Portable Drawer Design: Includes a portable drawer at the bottom for easy storage and management of various adapters.

Comprehensive Configuration: Comes with 9 different sizes of adapter connectors and special connectors for BMW and Mercedes-Benz.

The cleaning tank can be used either in conjunction with the device or separately.

Two independent fuel pumps operate separately during the test. If one pump fails, the other pump can still ensure proper testing of the fuel injectors.



15 Functions Available



Voltages Selection



Wide Compatibility



Heating The Cleaning Fluid



Practical Drawer Design



Color Display Screen

## Various Connectors



∅ 11mm

∅ 12mm

∅ 12.5mm

∅ 13mm

∅ 13.6mm

∅ 14mm

∅ 15mm

∅ 15.8mm

For BMW



No corrosive liquids



Prevent any leakage



No open flames



Wear eye protection

## Quick Guide

### ULTRASONIC CLEANING

1 - Pour the dedicated injector cleaning solution.

1

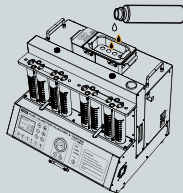

3 - Select the ultrasonic cleaning function 01 and press the confirm button (C) to input the pulse signal to the injector.

3

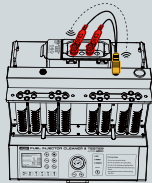
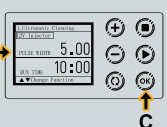

2 - Connect the injector with the pulse signal cable (A) and place it in the cleaning tank (B).

2

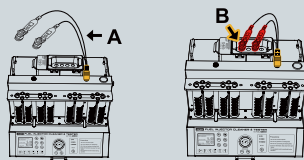

4 - Press the start button (D) on the ultrasonic cleaner panel to begin the process.

4

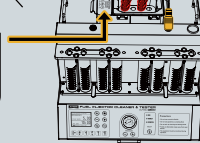

### FUEL INJECTOR TESTING

1 - Wear goggles first and then add in the dedicated test fluid.

1

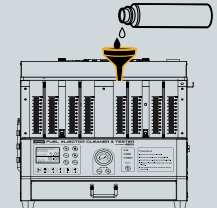

2 - Install the injectors onto the oil distributor (A), secure the distributor onto the main unit (B), and then start testing.

2

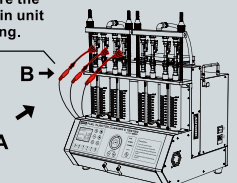
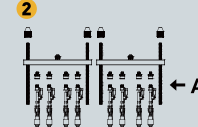

Power Supply	AC110V or AC220V	Supported Injector Types	GDI/EFI/FSI/Ordinary
Cleaning Tank Capacity	550ml	System Pressure	0~0.8Mpa
Glass Tube Capacity	110ml	Time Setting	0-10min
Analog Speed Range	0~7500RPM	Ultrasonic Cleaning Frequency	28kHz
Times of Injections	0~9900 times	PWM Pulse Width	0~40ms





**AUTOOL**

RELIABLE TOOLS FOR  
RELIABLE REPAIRS



# SMOKE LEAK DETECTOR

The AUTOOL Automotive Smoke Leak Detector is primarily used to inspect the tightness of various parts of a car, providing visual identification of any leakage issues. It features a newly designed intelligent pressure control and temperature protection system, ensuring a continuous output of stronger and more consistent smoke. This saves users time and improves efficiency, serving as a helpful tool and reliable assistant for quickly and accurately determining whether faults are caused by pipe leaks in vehicle pipeline systems.

SML310	14
SML330	15
SML400	16
SML500	17



# SMOKE LEAK DETECTOR

The AUTOOL SML310 Automotive Smoke Leak Detector is primarily used to inspect the tightness of various parts of a car, providing visual identification of any leakage issues. It features a newly designed intelligent pressure control and temperature protection system, ensuring a continuous output of stronger and more consistent smoke. This saves users time and improves efficiency, serving as a helpful tool and reliable assistant for quickly and accurately determining whether faults are caused by pipe leaks in vehicle pipeline systems.

Two Testing Modes: Air Mode / Smoke Mode.

Rapid Pipeline Leak Detection: Supports testing the airtightness of various pipeline systems, including automotive intake systems, EVAP systems, exhaust systems, and engines.

Overheat Protection: Prevents dry burning with an alarm indicator light. Automatically stops operation if the temperature exceeds 75°C.

Power Source: Operates on DC12V power with two built-in air pumps to suit different working conditions.

Large Smoke Output Volume: Generates smoke within 5 seconds; working pressure can exceed 1 bar, with a smoke flow rate  $\leq 6$  L/min. Can produce a large amount of smoke within 30 seconds to locate leaks.

Oil Drain Valve: Allows for recovery of residual smoke oil after use, promoting environmental friendliness and enabling reuse of test oil.

Visual Pressure Gauge: Observes the pressure state of the pipeline system through the gauge, helping to identify potential leaks.

Wide Application Range: Suitable for all types of vehicles, including passenger cars, motorcycles, off-road vehicles, snowmobiles, and speedboats.

SML310

SMOKE LEAK DETECTOR



## APPLICATIONS



Intake System Test



Exhaust System Test



Car Sealing Test



Various Pipe Fittings Test



Fuel Tank System Test



Crankcase System Test



Power Cable

EVAP Special Connector

Test Oil Refill Bottle

Valve Core Wrench

Universal Airbag Adapter

Rubber Connector Parts

Standard Cone Adapter

Standard Cone Adapter

Smoke Hose

## Hard Rubber Hose Plug

Used for sealing the hose.



Ø 5/10mm

Ø 9/15mm

Ø 14/19mm

Ø 18/26mm

Ø 25/35mm

Ø 32/45mm

Ø 45/60mm

Ø 60/75mm

Power Supply	DC 12V/5A	Output Pressure	<15psi
Rated Power	65W	Gross Weight/Net Weight	3.6kg/3.2kg
Air Pressure Output	Built-in air pump	Main Unit Size	250x160x165mm
Output Flow Rate	<6L/min	Packaging Size	295x295x210mm





# SMOKE LEAK DETECTOR

The AUTOOL SML330 Automotive Smoke Leak Detector is primarily used to inspect the tightness of various parts of a car, providing visual identification of any leakage issues. It features a newly designed intelligent pressure control and temperature protection system, ensuring a continuous output of stronger and more consistent smoke. This saves users time and improves efficiency, serving as a helpful tool and reliable assistant for quickly and accurately determining whether faults are caused by pipe leaks in vehicle pipeline systems.

Two Testing Modes: Air Mode / Smoke Mode.

Rapid Pipeline Leak Detection: Supports testing the airtightness of various pipeline systems, including automotive intake systems, EVAP systems, exhaust systems, and engines.

Overheat Protection: Prevents dry burning with an alarm indicator light. Automatically stops operation if the temperature exceeds 75°C.

Power Source: Operates on DC12V power with two built-in air pumps to suit different working conditions.

Large Smoke Output Volume: Generates smoke within 5 seconds; working pressure can exceed 1 bar, with a smoke flow rate  $\approx 6$  L/min. Can produce a large amount of smoke within 30 seconds to locate leaks.

Smoke Flow Meter Window: Allows adjustment of smoke flow rate through a rotary knob.

Oil Drain Valve: Recovers residual smoke oil after use, promoting environmental friendliness and enabling reuse of test oil.

Visual Pressure Gauge: Monitors the pressure state of the pipeline system through the gauge to detect potential leaks.

Wide Application Range: Suitable for all types of vehicles, including passenger cars, motorcycles, off-road vehicles, snowmobiles, and speedboats.



## APPLICATIONS

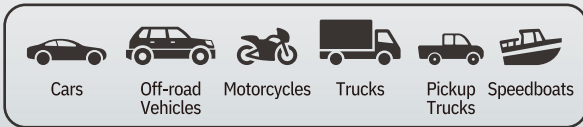

Intake System Test



Exhaust System Test



Car Sealing Test



Various Pipe Fittings Test



Fuel Tank System Test



Crankcase System Test



Power Cable

EVAP Special Connector

Test Oil Refill Bottle

Valve Core Wrench

Universal Airbag Adapter

Rubber Connector Parts

Standard Cone Adapter

Standard Cone Adapter

Smoke Hose

## Hard Rubber Hose Plug

Used for sealing the hose.



Ø 5/10mm

Ø 9/15mm

Ø 14/19mm

Ø 18/26mm

Ø 25/35mm

Ø 32/45mm

Ø 45/60mm

Ø 60/75mm

Power Supply	DC 12V/5A	Output Pressure	<15psi
Rated Power	65W	Gross Weight/Net Weight	3.7kg/3.2kg
Air Pressure Output	Built-in air pump	Main Unit Size	250x160x165mm
Output Flow Rate	<6L/min	Packaging Size	295x295x205mm

# SMOKE LEAK DETECTOR

The AUTOOL SML400 Automotive Smoke Leak Detector is primarily used to inspect the tightness of various parts of a car, providing visual identification of any leakage issues. It features a newly designed intelligent pressure control and temperature protection system, ensuring a continuous output of stronger and more consistent smoke. This saves users time and improves efficiency, serving as a helpful tool and reliable assistant for quickly and accurately determining whether faults are caused by pipe leaks in vehicle pipeline systems.

Three testing modes: Pressure Holding Mode, Air Mode, and Smoke Mode, catering to different pipeline system requirements.

Pressure holding leak detection displays the judgment result (Leak/No Leak) and supports testing the airtightness of various pipeline systems, including automotive intake systems, EVAP systems, exhaust systems, crankcase systems, and engines.

HD digital display, with clear visibility of the pressure-holding countdown, ensuring high reliability of the test results.

Overheat Protection: Prevents dry burning with an alarm indicator light. Automatically stops operation if the temperature exceeds 75°C.

Operates on DC12V power with two built-in air pumps to suit various working conditions.

Large Smoke Output Volume: Generates smoke within 5 seconds; working pressure can exceed 1 bar, with a smoke flow rate  $\leq 10$  L/min. Can produce a large amount of smoke within 30 seconds to locate leaks.

Oil Level Gauge Window: Allows real-time monitoring of the current oil level, making it easy for operators to refill as needed.

Smoke Flow Meter Window: Allows adjustment of the smoke flow rate through a rotary knob.

Oil Drain Valve: Recovers residual smoke oil after use, promoting environmental friendliness and enabling reuse of test oil.

Visual Pressure Gauge: Monitors the pressure state of the pipeline system through the gauge to detect potential leaks.

Wide Application Range: Suitable for all types of vehicles, including passenger cars, motorcycles, off-road vehicles, snowmobiles, and speedboats.



## APPLICATIONS

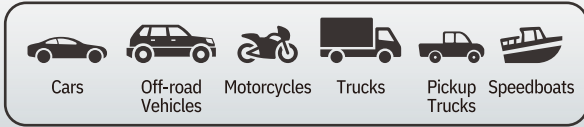

EVAP System Test



Various Pipe Fittings Test



Turbo System Test



Crankcase System Test



Intake System Test



Exhaust System Test



### Hard Rubber Hose Plug

Used for sealing the hose.



### Soft Rubber Hose Plug

Used for sealing the hose.

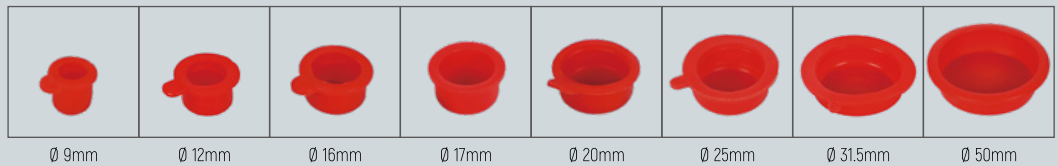

Power Supply	DC 12V/5A	Output Flow Rate	<10L/min
Rated Power	70W	Output Pressure	<45psi
Air Pressure Output	Built-in air pump	Net Weight	5.5kg
Pressure Hold Time	Countdown of 10 minutes	Main Unit Size	170x280x195mm





# SMOKE LEAK DETECTOR

The AUTOOL SML500 Automotive Smoke Leak Detector is primarily used to inspect the tightness of various parts of a car, providing visual identification of any leakage issues. It features a newly designed intelligent pressure control and temperature protection system, ensuring a continuous output of stronger and more consistent smoke. This saves users time and improves efficiency, serving as a helpful tool and reliable assistant for quickly and accurately determining whether faults are caused by pipe leaks in vehicle pipeline systems.

Two Testing Modes: Pressure Holding Mode/Smoke Leak Detection Mode, catering to different pipeline system needs.

Pressure holding leak detection displays the judgment result (Test Passed/Threshold Exceeded) and supports testing the airtightness of various pipeline systems, including automotive intake systems, EVAP systems, exhaust systems, crankcase systems, and engines.

HD LCD display with touchscreen control, providing accurate numerical readings and reliable testing results.

Supports pressure holding tests up to 500 kPa, with the ability to set the pressure target value within the 0-500 kPa range.

Operates on a 220V power supply with an external air source, suitable for various working environments.

Overheat Protection: Prevents dry burning with an alarm indicator light. Automatically stops operation if the temperature exceeds 75°C.

Large Smoke Output Volume: Generates smoke within 5 seconds; working pressure can exceed 1 bar, with a smoke flow rate  $\leq 6$  L/min. Can produce a large amount of smoke within 30 seconds to locate leaks.

Smoke Flow Meter Window: Allows adjustment of the smoke flow rate through a rotary knob.

Oil Drain Valve: Recovers residual smoke oil after use, promoting environmental friendliness and enabling reuse of test oil.

Wide Application Range: not only professionally suitable for automotive EVAP testing standards but also capable of testing the airtightness of power battery packs.



SML500

SMOKE LEAK DETECTOR

## APPLICATIONS

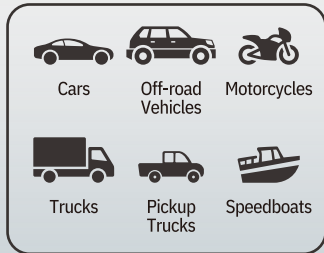

EVAP System Test



Various Pipe Fittings Test



Turbo System Test



Crankcase System Test



Intake System Test



Exhaust System Test



**Hard Rubber Hose Plug** Used for sealing the hose.



**Soft Rubber Hose Plug** Used for sealing the hose.

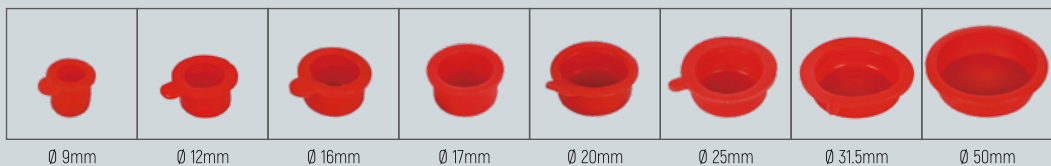

Power Supply	AC 110V/220V	Pressure Sensor Range	0-500Kpa
Rated Power	100W	Pressure Sensor Accuracy	0.5%FS
Air Source	External air source	Detection Time	0-655 seconds
External Air Source Pressure Range	0-10bar	Operation Interface	4.3-inch LCD HD touch screen



**AUTOOL**

RELIABLE TOOLS FOR  
RELIABLE REPAIRS



# SMART ARTICULATING BORESCOPE

The AUTOOL Smart Articulating Borescope series breaks through the technical limitations of traditional industrial borescopes by introducing the functionality to control the bending of the lens arbitrarily, supporting 360° articulating in four directions. The handheld integrated body allows single-handed operation control, while the high-definition camera effortlessly captures faults and flaws in narrow and hidden spaces. The inspection results are directly presented on a high-definition display screen or mobile devices such as smartphones.

SVB303	19
SVB308	20
SVB403	21
SVB405	22
SVB408	23





# FOUR-WAY ARTICULATING BORESCOPE

The AUTOOL SVB303 Four-Way Articulating Borescope breaks through the technical limitations of traditional industrial borescopes by introducing the functionality to control the bending of the lens arbitrarily, supporting 360° free rotation & 180° bending in four directions. The handheld integrated body allows single-handed operation control, while the million-pixel HD camera effortlessly captures faults and flaws in narrow and hidden spaces. The inspection results are directly presented on a HD display screen or mobile devices such as smartphones.

**Four-Way Articulating Lens:** Provides comprehensive, corner-to-corner detection for various environments.

**Over-Temperature Resistant Probe Design:** Features intelligent over-temperature protection with automatic power-off alarm at over 90°C.

**1080P HD Blue Light Camera:** Allows rapid focus and recording with a single button.

**Equipped with 6 High-Intensity LED Lights:** Adjustable brightness settings in three levels.

**Removable Battery Compartment Cover:** Includes a 2600mAh lithium battery for extended battery life.

**Base with Strong Magnetic Mounting Design:** Makes work and storage easy.

**Handheld, Detachable, Flexible Tube Design:** Facilitates quick and easy accessory changes.

**High Compatibility:** Supports smartphones or tablets with iOS, Android, and HarmonyOS systems.



SVB303

FOUR-WAY ARTICULATING BORESCOPE



4-way Articulation



One-Button Photo & Video Capture



Over-Temperature Protection



1080P HD Camera



Metal Mobile Phone Holder



IP67 Waterproof

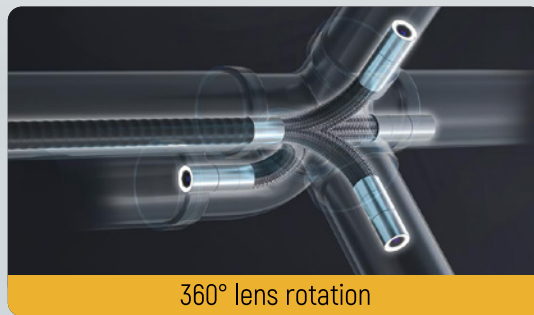

360° lens rotation

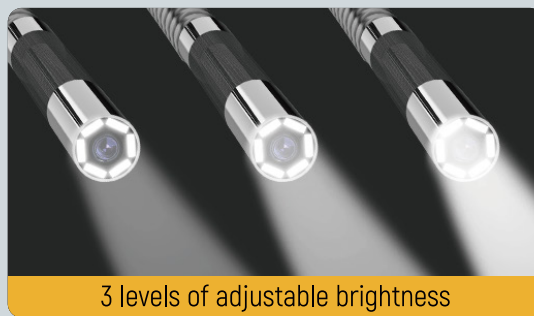

3 levels of adjustable brightness

Input Power	DC 5V/1A	Articulation Direction	Four-way
Camera Diameter	6.2mm	Articulation Angle	180°
Pixel	1920x1080px	Battery Capacity	2600mAh
Field of View	90°	Waterproof Rating	IP67
Flexible Tube Length	1m	Operating Environment	-10°C-50°C
Flexible Tube Material	Metal	Main Unit Dimensions	298x57x123mm



# SVB308

AUTOOL

20

SVB308

FOUR-WAY ARTICULATING BORESCOPE

# FOUR-WAY ARTICULATING BORESCOPE

The AUTOOL SVB308 Four-Way Articulating Borescope breaks through the technical limitations of traditional industrial borescopes by introducing the functionality to control the bending of the lens arbitrarily, supporting 360° free rotation & 180° bending in four directions. The handheld integrated body allows single-handed operation control, while the million-pixel HD camera effortlessly captures faults and flaws in narrow and hidden spaces. The inspection results are directly presented on a HD display screen.

**Four-Way Articulating Lens:** Provides comprehensive, corner-to-corner detection for various environments.

**4.3-inch HD Display Screen:** Supports image zooming in and out for clearer detail viewing.

**1080P HD Blue Light Camera:** Allows rapid focus and recording with a single button.

**Over-Temperature Resistant Probe:** Features intelligent over-temperature protection with automatic alarm at over 90°C.

**Built-in 32GB Memory Card:** Can store a large number of photos and videos.

**Equipped with 6 High-Intensity LED Lights:** Adjustable brightness settings in three levels.

**Removable Battery Compartment Cover:** Includes a 2600mAh lithium battery for extended battery life.

**Base with Strong Magnetic Mounting Design:** Makes work and storage easy.

**Handheld, Detachable, Flexible Tube Design:** Facilitates quick and easy accessory changes.



4-way  
Articulation



One-Button  
Photo & Video  
Capture



Over-Temperature  
Protection



HD Camera



Screen Detachable  
Design



IP67  
Waterproof

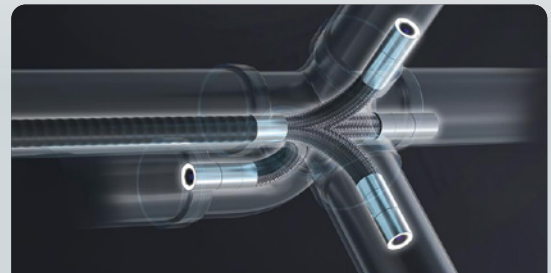

360° lens rotation

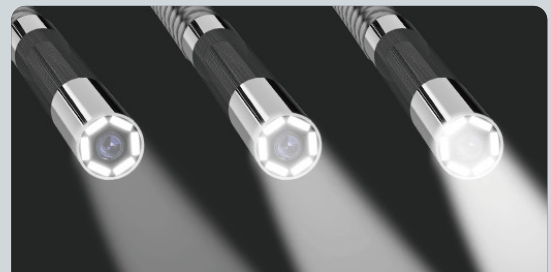

3 levels of adjustable brightness

Input Power	DC 5V/1A	Articulation Direction	Four-way
Camera Diameter	6.2mm	Articulation Angle	180°
Pixel	1280x760px	Battery Capacity	2600mAh
Field of View	90°	Waterproof Rating	IP67
Flexible Tube Length	1m	Operating Environment	-10°C-50°C
Flexible Tube Material	Metal	Main Unit Dimensions	308x128x123mm





SVB403

# ARTICULATING VIDEO BORESCOPE

The AUTOOL SVB403 Articulating Video Borescope is specially designed for inspecting hard-to-reach, narrow and curved spaces such as the car evaporator, combustion chamber, and catalytic converter sensors. It features a two-way 210° steering function and high-temperature protection. This allows users to maneuver the small probe into tight spaces and capture vivid, clear, and comprehensive videos and images on the display screen, meeting the diverse inspection needs of automotive technicians.



4.3-inch Ultra HD Display Design: Supports 8x zoom for clearer viewing of details.

210° Wide-Angle Smart Steering: Equipped with a 6.5mm dual lens for all-around, full angle inspection.

Over-Temperature Resistant Probe Design: Automatically powers off with an alarm when exceeding 90°C.

1080P Ultra HD Blue Light Camera: Features one-click fast focusing for photography and video recording.

International Standard IP67 Waterproof Lens Design: Resists harsh environments.

The lens is equipped with 6 built-in high-brightness LED lights, made from durable material that is resistant to breakage, with three adjustable brightness levels.



210° Two-way Articulation



Dual Ultra HD Cameras (Vertical & Side)



8x Optical Zoom



4.3 Inch Display



LED Light Control



IP67 Waterproof



Photo/Video Button



Rear Work Light

Camera Diameter	Dual-lens 6.5mm	Battery Capacity	2000mAh
Pixels	Front Lens 1280x720; Side Lens 1280x720	Camera Light Source	6 LEDs for Front View / 1 LED for Side View
Screen Size	4.3 inches	Waterproof Rating	IP67
Languages	8 types	Flexible Tube Material	Wear-resistant Metal Hose
Depth of Field	Front Lens 25-100mm; Side Lens 15-60mm	Flexible Tube Length	1m
Field of View	70°	Over-Temperature Protection	Smart over-temperature protection, device automatically shuts down
Manual Brightness Adjustment	Support three levels	Articulation Direction	Two directions
Power Supply	5V	Articulation Angle	Maximum 210°
Usage Duration	3 hours	Bending Radius	35mm



SVB405

AUTOOL

22

# ARTICULATION VIDEO BORESCOPE

The AUTOOL SVB405 Articulation Video Borescope is a multifunctional device designed specifically for inspecting narrow, curved, and enclosed spaces. It breaks through the limitations of traditional industrial borescope technology, with the lens supporting 360° free rotation and 180° bending in four directions. Additionally, it features 8x optical zoom for sharp, clear detail, allowing for precise detection of small defects in tight spaces. The device has a built-in 4.3-inch HD color screen, eliminating the need for external devices, and offers full-process operation with one-handed control for capturing photos and videos.



SVB405

ARTICULATION VIDEO BORESCOPE

**360° Four-Directional Articulating Lens:** Rotates 360° in four directions, allowing flexible navigation through complex pipes and ensuring full-range detection.

**8x HD Zoom Function:** Switch between near and far views to capture every small defect in hidden spaces with precision.

**4.3-inch HD Color Screen:** Supports 5 brightness levels for real-time, true-to-life color display, showing detailed vehicle interior inspection images.

**Over-Temperature Alarm:** The lens features a smart temperature sensor. If the environment exceeds 90°C, an alarm triggers, and an over-temperature warning appears. The image resumes automatically once the temperature drops.

**IP67 Waterproof Rating:** The lens is IP67 waterproof, offering resistance to water and oil, and ensuring stable operation in humid environments.

**32GB Memory Card:** Offers fast read/write speeds and ample storage, supporting HD video and photo storage. Replaceable when full.

**Work Light Design:** Equipped with multiple light sources, including 6 high-intensity LED lights, and a rear work light, adjustable to meet environmental needs.

**Versatile Applications:** Ideal for automotive repair, mechanical maintenance, appliance repair, circuit inspections, pipeline diagnostics, air conditioning servicing, and more.



Rear Work Light



4-way Articulation



8x Optical Zoom



4.3 Inch Display



Over-Temperature Protection



LED Light Control



IP67 Waterproof

Input Power	DC 5V/1A	Articulation Direction	Four directions
Camera Diameter	6.45mm	Articulation Angle	180°
Pixel	2 million pixels	Battery Capacity	2000mAh
Field of View	80°	Waterproof Rating	IP67
Flexible Hose Length	1m	Operating Environment	-10°C-80°C
Flexible Hose Material			Wear-resistant metal hose





# ARTICULATION VIDEO BORESCOPE

The AUTOOL SVB408 Articulation Video Borescope is a multifunctional device designed for inspecting curved and narrow enclosed spaces. It breaks through the limitations of traditional industrial borescope technology, featuring a 3.9mm ultra-fine probe that supports 360° free rotation and four-direction 180° bending. Additionally, it is equipped with an 8x zoom function, providing sharp and clear detail capture, allowing precise detection of small defects in tight spaces. The device has a built-in 4.3-inch HD color screen, eliminating the need for external devices, and offers full-process operation with one-handed control for capturing photos and videos.



**3.9mm Ultra-Fine Probe:** Supports 360° free rotation and four-direction 180° bending, allowing flexible navigation through various complex piping systems, easily reaching hard-to-access spaces such as gearbox gear sets.

**8x HD Zoom Function:** Switch between near and far views to capture every small defect in hidden spaces with precision.

**4.3-inch HD Color Screen:** Supports 5 brightness levels for real-time, true-to-life color display, showing detailed vehicle interior inspection images.

**32GB Memory Card:** Offers fast read/write speeds and ample storage, supporting HD video and photo storage. Replaceable when full.

**IP67 Waterproof Rating:** The lens is rated IP67 for excellent water and oil resistance, ensuring stable operation in humid pipes.

**LED Light with 3-Level Adjustment:** The lens is equipped with 6 high-intensity LED lights made from gallium arsenide material, which is tough and durable. It also supports 3 brightness levels for flexible lighting.

**Over-Temperature Alarm:** The lens features a smart temperature sensor. If the environment exceeds 90°C, an alarm triggers, and an over-temperature warning appears. The image resumes automatically once the temperature drops.

**Versatile Applications:** Ideal for automotive repair, mechanical maintenance, appliance repair, circuit inspections, pipeline diagnostics, air conditioning servicing, and more.



4-way Articulation



8x Optical Zoom



4.3 Inch Display



Over-Temperature Protection



LED Light Control



IP67 Waterproof



Photo/Video Button

<b>Input Power</b>	DC 5V/1A	<b>Articulation Direction</b>	Four directions
<b>Camera Diameter</b>	3.9mm	<b>Articulation Angle</b>	180°
<b>Pixel</b>	1 Megapixel	<b>Battery Capacity</b>	2000mAh
<b>Field of View</b>	70°	<b>Waterproof Rating</b>	IP67
<b>Flexible Hose Length</b>	1m	<b>Operating Environment</b>	-10°C-80°C
<b>Flexible Hose Material</b>			Wear-resistant metal hose

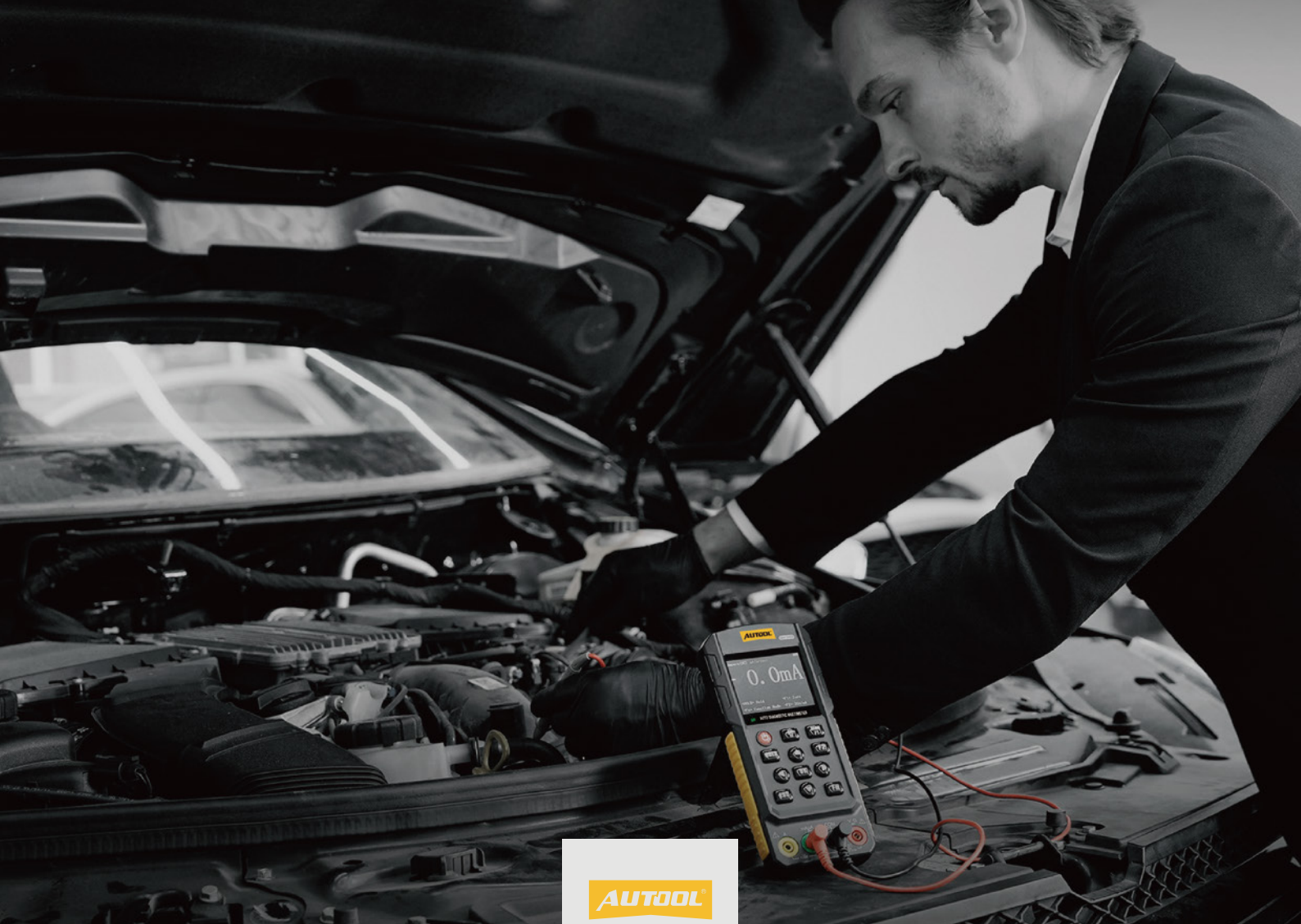

**AUTOOL**

RELIABLE TOOLS FOR  
RELIABLE REPAIRS



# AUTO DIAGNOSTIC MULTIMETER

The AUTOOL Automotive Diagnostic Multimeter is expertly designed for the automotive repair industry, serving as a versatile instrument tailored to measure and test various automotive circuit systems. Equipped with advanced oscilloscope functionality, it adeptly detects automotive circuits, ignition pulses, relays, and fuel injectors, amongst other critical components. Additionally, it facilitates seamless testing of K-line and CAN data for the car's OBD system, making it compatible with a wide variety of vehicle models, including trucks, cars, buses, electric vehicles, and more..

DM301/ DM303

25-26





# AUTO DIAGNOSTIC MULTIMETER



## DM301



## DM303 (ADVANCED VER.)

6 Testing Functions: Voltage measurement, current measurement, resistance measurement, oscilloscope mode, ignition pulse signal testing, and frequency measurement.

Intelligent Overload Protection: Smart overheat protection with overload safeguards; in case of a short circuit, power is immediately cut off to prevent equipment damage.

Multiple Power Supply Options: Supports lithium batteries (optional), dry batteries, and TYPE-C for power supply.

Built-in LED Work Light: Operates effectively in dark environments, meeting various work scenario needs.

HD 2.8-Inch Color Display: Provides clear and easy-to-read data.

Button Control Panel: Simple, intuitive, and easy-to-use controls.

Compact and Portable: Small size for easy carrying, comes with a tool case for convenient storage and management of various connection cables.

13 Testing Functions: Voltage measurement, current measurement, resistance measurement, oscilloscope mode, automotive circuit testing, automotive cranking testing, fuel injector testing, relay testing, simulated signal testing, ignition pulse signal testing, K/LIN line data reading, CAN line data reading, and frequency measurement.

Intelligent Overload Protection: Smart overheat protection with overload safeguards; in case of a short circuit, power is immediately cut off to prevent equipment damage.

Multiple Power Supply Options: Supports lithium batteries (optional), dry batteries, TYPE-C, and battery clip connections for power supply.

Built-in LED Work Light: Operates effectively in dark environments, suitable for various work scenarios.

High-Definition 2.8-Inch Color Display: Provides clear and easily readable data.

Button Control Panel: Simple, intuitive, and easy-to-use controls.

Compact and Portable: Small size for easy carrying, comes with a tool case for convenient storage and management of various connection cables.



Voltage Measurement



Current Measurement



Resistance Measurement



Oscilloscope



Ignition Pulse Signal Test



Frequency Measurement

Model	DM301	DM303
Available Testing Modes	6	13
Voltage Measurement Range	DC 0-1000V, AC 0-700V	DC 0-1000V, AC 0-700V
Current Measurement Range	0-20A, 0-200mA	0-20A, 0-200mA
Resistance Measurement Range	0-1MΩ	0-1MΩ
Frequency Measurement Range	1Hz-1MHz	1Hz-1MHz
Automotive Circuit Drive Current	/	0-5A
Fuel Injector Drive Signal	/	500-6000RPM



## DM303 Accessories



## DM301 Accessories

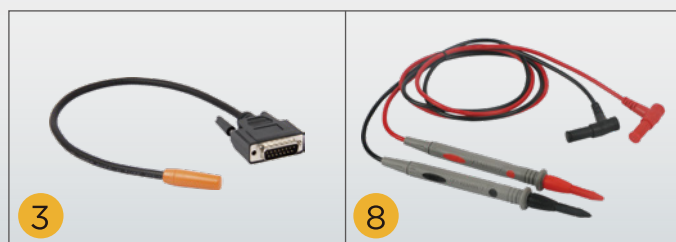

## APPLICATIONS

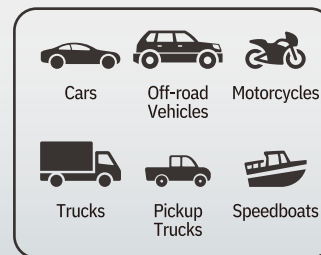

NO.	Name	Distribution Head No.	Functions	NO.	Name	Functions
1	Multi-functional detection line	C01-1	DC connector, connected to the battery clip line	3	Ignition signal detection line	Inductive high-voltage line signal
		C01-2	Injector / relay test			
		C01-K	K line signal line	4	Battery clip line	Connect the battery
		C01-CAN+	CAN+ signal line			
		C01-CAN-	CAN- signal line	5	Jumper (Yellow)	Connect multiple circuit connectors
		C01-GND	Ground wire			
		C01-SIN	Sine wave signal line	6	Jumper (Green)	Connect multiple circuit connectors
		C01-S1	5V signal line			
C01-S2	Square signal line	7	Jumper (Black)	Connect multiple circuit connectors		
2	Automotive circuit detection line				C02-1	DC connector, connected to the battery clip line
		C02-2	Probe terminal			





**AUTOOL**

RELIABLE TOOLS FOR  
RELIABLE REPAIRS



# 3D WHEEL ALIGNER

The AUTOOL 3D Wheel Aligner utilizes advanced 3D imaging technology and vehicle-centric measurement methods to provide real-time, highly precise wheel alignment data. This system offers superior accuracy and stability, streamlined by professional alignment techniques that ensure fast and easy operation. Unconstrained by lift platforms or spatial limitations, it is designed to fit various service environments, including tire shops, auto service centers, and dealerships. With a robust and constantly updated database, this system caters to a wide range of automotive alignment needs, offering enhanced flexibility and broader coverage in the automotive service industry.

XC505

28

XC508

29

# 3D WHEEL ALIGNER



The AUTOOL XC505 3D Wheel Aligner utilizes cutting-edge 3D imaging technology and vehicle-centric measurement methods for real-time, high-precision detection of wheel alignment data, offering improved accuracy and stability. It features professional wheel alignment measurement technology with quick and easy operation. Compatible with four-post or large scissor lifts, meeting various usage scenarios. It also has robust database support with ongoing updates. Suitable for tire shops, auto repair shops, and car dealerships, it offers strong versatility and broad coverage.

**5-Megapixel Industrial-Grade Camera:** Provides clear images for faster measurement and more precise data.

**Scratch-Resistant, Waterproof, and Shockproof Target:** Offers strong interference resistance and accurate signal feedback; durable and robust.

**19-Inch Ultra-High-Definition Display:** Displays high-definition images clearly from any angle.

**Smart Module Design:** Features voice-guided instructions and LED prompts throughout the measurement process.

**Extensive Vehicle Database:** Covers 99% of vehicles on the market, with regular free updates to expand the database.

**Multilingual Support:** Offers various language settings to meet the needs of different regions and diverse user groups.

**Portable integrated cabinet with swivel casters,** making it easy to move and not limited by the location.



Safe & Stable



Car Model Database



Precise Positioning



Fast & Efficient



Voice Guidance



All-in-one Cabinet

Measurement Technology	Precision	Precision Range	Maximum Test Range
Toe Angle	±0.01°	±2°	±20°
Camber Angle	±0.01°	±2°	±20°
Kingpin Inclination	±0.02°	±15°	±20°
Negative Caster	±0.02°	±10°	±20°
Thrust Angle	±0.02°	±2°	±10°

Power Supply	AC 110V/220V	Lift Lane Height Difference	Left-right Difference <5mm
Display	19" Color LCD Displays	Wheel Rim Size Measurable	13"-23"
Resolution	1920x1080px	Relative Humidity	≤85%
Lighting Requirement	No direct exposure to strong infrared light	Cabinet	Included





# 3D WHEEL ALIGNER

The AUTOOL XC508 3D Wheel Aligner utilizes cutting-edge 3D imaging technology and vehicle-centric measurement methods to provide real-time, highly precise wheel alignment data. This system offers superior accuracy and stability, streamlined by professional alignment techniques that ensure fast and easy operation. Unconstrained by lift platforms or spatial limitations, it is designed to fit various service environments, including tire shops, auto service centers, and dealerships. With a robust and constantly updated database, this system caters to a wide range of automotive alignment needs, offering enhanced flexibility and broader coverage in the automotive service industry.

**Smart tracking & lifting system:** The camera automatically tracks the target and adjusts the lift height accordingly. It is compatible with various types of lifts and provides precise positioning.

**Features a high-definition camera with 5 million industrial pixels for clear images, speeding up measurements and improving data accuracy.**

**Durable alignment target:** Scratch-resistant, waterproof, and drop-resistant with strong anti-interference. Provides accurate feedback and is built to last.

**The dual 19-inch HD color displays offer a wide field of view and can simultaneously show measurement data on both screens, facilitating synchronized operation and data correction when adjusting the vehicle frame.**

**Intelligent module design:** Includes full voice guidance and LED prompts for easy and accurate measurement.

**Extensive vehicle model database:** Covers 99% of vehicles on the market, with regular free updates to expand the database.

**Multi-language support:** Offers multiple language settings to accommodate users from different regions and backgrounds.

**Portable integrated cabinet with swivel casters, making it easy to move and not limited by the location.**

**Built-In Printer:** Allows for immediate printing of test results after completion.



Automatically Tracking System



Printer Setup



Dual-screen Display



Movable Workstation



Voice Guidance



Precision Alignment



Multi-angle Movable Display Screen



Smart tracking & lifting System

Measurement Technology	Precision	Precision Range	Maximum Test Range
Toe Angle	±0.01°	±2°	±20°
Camber Angle	±0.01°	±2°	±20°
Kingpin Inclination	±0.02°	±15°	±20°
Negative Caster	±0.02°	±10°	±20°
Thrust Angle	±0.02°	±2°	±10°

Power Supply	AC 110V/220V	Lift Lane Height Difference	Front and Rear Difference <5mm
Display	Dual 19" Color LCD Displays	Wheel Rim Size Measurable	13"-23"
Resolution	1920x1080px	Relative Humidity	≤85%
Lighting Requirement	No direct exposure to strong infrared light	Cabinet	Included



# WALNUT SHELL BLASTING MACHINE

The AUTOOL Walnut Shell Blasting Machine utilizes walnut shell abrasive cleaning technology, which is safe, environmentally friendly, and highly effective for cleaning carbon deposits in automotive engine intake and exhaust systems. The principle of operation involves spraying walnut shell abrasive into the engine's intake manifold using high-pressure airflow. The high-pressure, high-speed walnut shell abrasive particles tumble and impact within the enclosed intake manifold, dislodging carbon deposits from the intake valves and cylinder. The walnut shell abrasive and carbon deposit mixture is then recovered through a specialized connector. By repeating this process, the accumulated carbon on the intake valves and intake pipes is brushed away. The entire carbon cleaning process is carried out without dismantling the main engine components, making it quick, efficient, safe, and reliable.

**AUTOOL**

RELIABLE TOOLS FOR  
RELIABLE REPAIRS

WD616

31

WD716

32

WD816

33





# WALNUT SHELL BLASTING MACHINE

The AUTOTOOL WD616 Walnut Shell Blasting Machine utilizes walnut shell abrasive cleaning technology to safely and environmentally clean carbon deposition in automotive engine intake and exhaust systems. Its operating principle involves walnut shell abrasive being sprayed into the engine intake manifold through high-pressure air. The high-speed, high-pressure abrasive particles roll and impact within the enclosed intake manifold, dislodging carbon deposits from the intake valves and cylinder walls. The walnut shell abrasive and carbon mixture is then recovered through a dedicated connector. This allows for the cleaning of carbon deposit in the combustion chamber without disassembling the engine's major components, making it quick, efficient, safe, and reliable.



**Walnut shell abrasive cleaning technology:** Efficiently cleans carbon deposits attached to the automotive intake manifold, valves, and combustion chamber.

**Large-capacity 30L pressure walnut shell abrasive tank.** Connects to an external air compressor, allowing for pressure and flow adjustments during pipeline flushing to improve efficiency.

**1400W High-Power Motor:** Supports 110/220V power supply, with stable performance and strong spray force, suitable for Europe, America, and Asia.

**Safe and Non-harmful Physical Cleaning:** Uses walnut shells as abrasives, free from harmful chemicals, with corrosion resistance and cleaning ability to effectively remove various contaminants, rust, and old coatings from metal surfaces.

**Built-in filter:** Captures used walnut shell abrasive for recycling, making it environmentally friendly and cost-effective.

**Wide applicability and complete specifications:** Equipped with various connectors, supporting cleaning for over 99% of vehicle sizes on the market.



Deep Removal Of Carbon Deposit



External Air Source



Built-in Dust Filter



Integrated Design



Carbon Deposits Cleaning

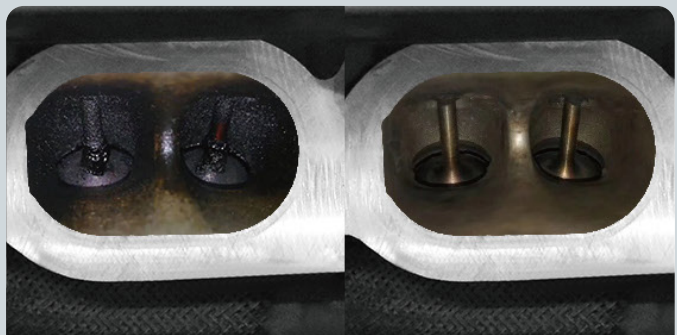

Before & After

Rated Power	1400W	Air Flow Rate	< 300L/min
Pressure Setting	/	Rated Frequency	50/60HZ
Vacuum Suction	0.02MPa	Machine Capacity	30L
Rated Voltage	AC 110V/220V	Product Weight	20.5KG

# WALNUT SHELL BLASTING MACHINE



The AUTOOL WD716 Walnut Shell Blasting Machine utilizes walnut shell abrasive cleaning technology to safely and environmentally clean carbon deposition in automotive engine intake and exhaust systems. Its operating principle involves walnut shell abrasive being sprayed into the engine intake manifold through high-pressure air. The high-speed, high-pressure abrasive particles roll and impact within the enclosed intake manifold, dislodging carbon deposits from the intake valves and cylinder walls. The walnut shell abrasive and carbon mixture is then recovered through a dedicated connector. This allows for the cleaning of carbon deposit in the combustion chamber without disassembling the engine's major components, making it quick, efficient, safe, and reliable.

**Walnut shell abrasive cleaning technology:** Efficiently cleans carbon deposits attached to the automotive intake manifold, valves, and combustion chamber.

**Two Mode Options:** Standard Mode / Expert Mode to meet different operational needs.

**1600W High-Power Motor:** Supports 110/220V power supply, with stable performance and strong spray force, suitable for Europe, America, and Asia.

**Large-capacity 15L pressure walnut shell abrasive tank.** Features a visual pressure gauge and connects to an external air compressor, allowing for pressure and flow adjustments during pipeline flushing to improve efficiency.

**Safe and Non-harmful Physical Cleaning:** Uses walnut shells as abrasives, free from harmful chemicals, with corrosion resistance and cleaning ability to effectively remove various contaminants, rust, and old coatings from metal surfaces.

**Built-in filter:** Captures used walnut shell abrasive for recycling, making it environmentally friendly and cost-effective.

**Wide Applicability and Complete Specifications:** Comes with 23 types of connectors, supporting cleaning for over 99% of vehicle sizes on the market.

**Built-in Storage Box:** Includes a three-section retractable handle for convenient organization and storage of accessories.



Deep Removal Of Carbon Deposit



External Air Source



Built-in Dust Filter



Integrated Design

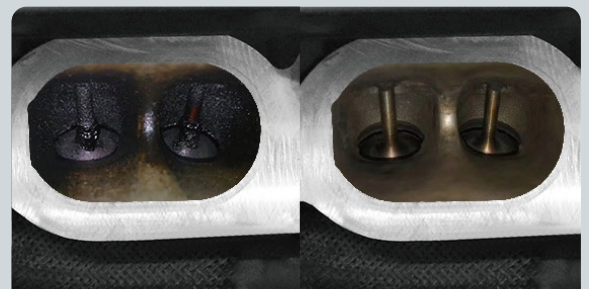

Before & After

Rated Power	1600W	Air Flow Rate	< 300L/min
Pressure Setting	Pressure Knob Adjustment	Rated Frequency	50/60HZ
Vacuum Suction	0.02MPa	Machine Capacity	15L
Rated Voltage	AC 110V/220V	Product Weight	52KG





# WALNUT SAND COMBUSTION CHAMBER DE-CARBON CLEANER

The AUTOOL WD816 Walnut Shell Blasting Machine utilizes walnut shell abrasive cleaning technology to safely and environmentally clean carbon deposition in automotive engine intake and exhaust systems. Its operating principle involves walnut shell abrasive being sprayed into the engine intake manifold through high-pressure air. The high-speed, high-pressure abrasive particles roll and impact within the enclosed intake manifold, dislodging carbon deposits from the intake valves and cylinder walls. The walnut shell abrasive and carbon mixture is then recovered through a dedicated connector. This allows for the cleaning of carbon deposit in the combustion chamber without disassembling the engine's major components, making it quick, efficient, safe, and reliable.

**Walnut shell abrasive cleaning technology:** Efficiently cleans carbon deposits attached to the automotive intake manifold, valves, and combustion chamber.

**Large-capacity 10L pressure walnut shell abrasive tank.** Features a visual pressure gauge and connects to an external air compressor, allowing for pressure and flow adjustments during pipeline flushing to improve efficiency.

**1600W High Power:** Supports 110/220V power supply, with strong suction for more thorough carbon removal, suitable for Europe, America, and Asia.

**Safe and Non-harmful Physical Cleaning:** Uses walnut shells as abrasives, free from harmful chemicals, with corrosion resistance and cleaning ability to effectively remove various contaminants, rust, and old coatings from metal surfaces.

**Built-in filter:** Captures used walnut shell abrasive for recycling, making it environmentally friendly and cost-effective.

**Wide Applicability and Complete Specifications:** Comes with multiple connectors, supporting cleaning for most of vehicle sizes on the market.

**Portable Integrated Design:** Equipped external 360 ° rotating reinforced casters for easy mobility during different operations.



Deep Removal Of Carbon Deposit



External Air Source



Built-in Dust Filter



Integrated Design



Carbon Deposits Cleaning



Rated Power	1600W	Air Flow Rate	< 300L/min
Pressure Setting	Pressure Knob Adjustment	Rated Frequency	50/60HZ
Vacuum Suction	0.02MPa	Machine Capacity	10L
Rated Voltage	AC 110V/220V	Product Weight	25KG



**AUTOOL**

RELIABLE TOOLS FOR  
RELIABLE REPAIRS

CO<sub>2</sub>

# DRY ICE BLASTING MACHINE

The AUTOOL Dry Ice Blasting Machine is a versatile cleaning tool designed for automotive maintenance, specifically tailored for engine carbon deposit removal. Utilizing high-speed airflow, dry ice particles are accelerated to remove carbon deposits effectively. The cleaned dry ice evaporates safely in the environment, leaving no residue and ensuring vehicle safety. This machine is ideal for cleaning engine compartments, cylinder combustion chambers, intake valves, throttle bodies, and more, serving multiple cleaning and maintenance purposes. AUTOOL integrates extensive practical experience into product development, emphasizing safety, reliability, intelligence, and user-friendliness.

HTS818

35

HTS828

36



# DRY ICE BLASTING MACHINE



The AUTOTOL HTS708 Dry Ice Blasting Machine is a versatile cleaning tool designed for automotive maintenance, specifically tailored for engine carbon deposits removal. Utilizing high-speed airflow, dry ice pellets are accelerated to remove carbon deposits effectively. The cleaned dry ice evaporates safely in the environment, leaving no residue and ensuring vehicle safety. This machine is ideal for cleaning engine compartments, cylinder combustion chambers, intake valves, throttle bodies, and more, achieving multiple cleaning and maintenance functions with one machine.

**Safe and Environmentally Friendly:** Uses gentle cleaning technology that cleans surfaces quickly and effectively without leaving any chemical pollutants.

**Intelligent Control Panel:** Provides intuitive operation with on/off buttons and dry ice quantity control.

**Large-Capacity Dry Ice Tank:** One-step carbon deposit cleaning.

**Visual Pressure Gauge:** Monitors output pressure in real-time.

**Dry Ice Quantity Control Button:** Precisely adjusts the amount of dry ice emitted.

**Multiple Nozzles Included:** Meets various cleaning needs.

**Portable and integrated design** with external 360 ° rotating reinforced casters and handle, suitable for mobility in various environments.

**Wide Applicability:** Supports cleaning of engine cylinder combustion chambers, valve carbon deposits, intake manifolds, catalytic converters, fuel vehicles, and engine compartments.

**Multiple Application Fields:** Suitable for automotive maintenance, industrial equipment, aerospace, construction, and other scenarios.

## Quick Guide

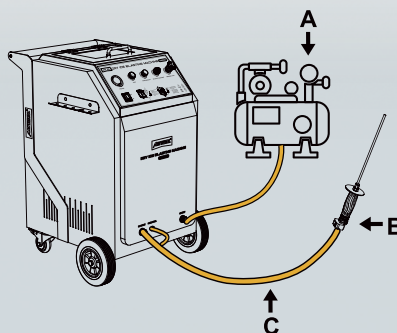

1. Connect an external air source(A) (pipe outside diameter > DN20, pressure > 6 bar).
2. Connect the control handle(B) and ice outlet hose(C).

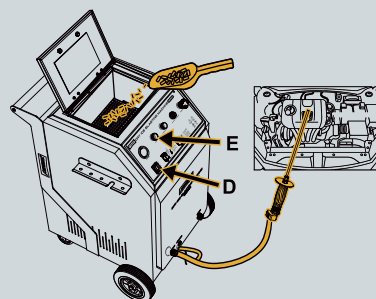

3. Turn on the power(D), add dry ice, and adjust the ice output.
4. Press the switch(E) to clean. After cleaning, set ice output to zero and spray for 30s to prevent ice blockage.



High-efficiency  
Cleaning



Pressure Gauge  
Display



Adjustable Dry  
Ice Amount



Eco-friendly  
& Safety



Widely  
Used



PREVENT ELECTRIC  
LEAKAGE



WEAR EYE  
PROTECTION



CHILDREN  
FORBIDDEN



WEAR  
GLOVES

Power Supply	AC 110V/220V	Dry Ice Particle Size	3mm, can use small ice blocks
Dry Ice Capacity	7.5kg	Dry Ice Feed Rate (Adjustable)	0-3.2kg/min
Compressed Air Flow	>1-3m <sup>3</sup> /min	Net Weight	60.3kg
Supply Air Pressure	0.3-1.0Mpa	Product Size	455x625x818mm

# DRY ICE BLASTING MACHINE

The AUTOOL HTS709 Dry Ice Blasting Machine is a versatile cleaning tool designed for automotive maintenance, specifically tailored for engine carbon deposit removal. Utilizing high-speed airflow, dry ice particles are accelerated to remove carbon deposits effectively. The cleaned dry ice evaporates safely in the environment, leaving no residue and ensuring vehicle safety. This machine is ideal for cleaning engine compartments, cylinder combustion chambers, intake valves, throttle bodies, and more, serving multiple cleaning and maintenance purposes. AUTOOL integrates extensive practical experience into product development, emphasizing safety, reliability, intelligence, and user-friendliness.

**Safe and Environmentally Friendly:** Uses gentle cleaning technology that cleans surfaces quickly and effectively without leaving any chemical pollutants.

**Intelligent Control Panel:** Provides intuitive operation with on/off buttons and dry ice quantity control.

**Dual-channel Pressure Display:** Simultaneously shows both inlet and outlet pressures.

**Large-Capacity Dry Ice Tank:** One-step carbon deposit cleaning.

**Visual Pressure Reading:** Real-time monitoring of operational status.

**Dry Ice Quantity Control Button:** Precisely adjusts the amount of dry ice.

**Multiple Nozzles Included:** Meets various cleaning needs.

**Portable and integrated design** with external 360° rotating reinforced casters and handle, suitable for mobility in various environments.

**Wide Applicability:** Supports cleaning of engine cylinder combustion chambers, valve carbon deposits, intake manifolds, catalytic converters, fuel vehicles, and engine compartments.

**Multiple Application Fields:** Suitable for automotive maintenance, industrial equipment, aerospace, construction, and other scenarios.



High-efficiency  
Cleaning



Dual Pressure  
Gauge Display



Adjustable Dry  
Ice Amount



Eco-friendly  
& Safety



Widely  
Used

HTS828

DRY ICE BLASTING MACHINE

## Quick Guide

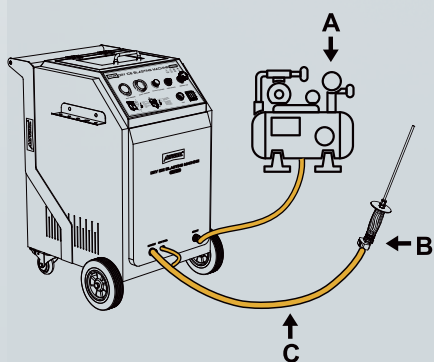

1. Connect an external air source(A)  
(pipe outside diameter > DN20, pressure > 6 bar).
2. Connect the control handle(B) and ice outlet hose(C).

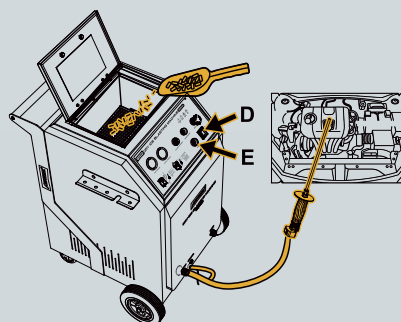

3. Turn on the power(D),  
add dry ice, and adjust  
the ice output.
4. Press the switch(E) to  
clean. After cleaning,  
set ice output to zero  
and spray for 30s to  
prevent ice blockage.



PREVENT ELECTRIC  
LEAKAGE



WEAR EYE  
PROTECTION



CHILDREN  
FORBIDDEN



WEAR  
GLOVES

Power Supply	AC 110V/220V	Dry Ice Particle Size	3mm, can use small ice blocks
Dry Ice Capacity	7.5kg	Dry Ice Feed Rate (Adjustable)	0-3.2kg/min
Compressed Air Flow	>1-3m <sup>3</sup> /min	Power	500W
Supply Air Pressure	0.3-1.0Mpa	Product Size	517x635x815mm





**AUTOOL**

RELIABLE TOOLS FOR  
RELIABLE REPAIRS



# BRAKE FLUID BLEEDER

The AUTOOL Brake Fluid Bleeder utilize a novel pulsating technology for brake fluid replacement. This technology emits continuous pulse signals to apply pressure to the brake fluid pipelines, effectively cleaning the lines. This ensures a more thorough replacement of brake fluid, preventing the formation of air bubbles during the oil change and filling process, thereby optimizing or eliminating the need for manual air bleeding.

AST605

38

AST612

39

AST618

40



# AST605

## BRAKE FLUID BLEEDER

The AUTOOL AST605 Brake Fluid Bleeder utilize a new pulsating technology for brake fluid replacement. It continuously applies pressure to the brake fluid pipelines in a pulse-like manner, effectively flushing the pipelines. This ensures a more thorough replacement of brake fluid, preventing the formation of air bubbles during the oil change and filling process, thereby optimizing or eliminating the need for manual air bleeding.

**Adopts New Pulsating Brake Fluid Exchange Technology:** Automatically removes air bubbles from the pipeline and cleans pipeline dirt, ensuring a more thorough oil change.

**Fully Automatic One-Click Oil Change:** Executes the entire oil change process with a single operation, making it simple and efficient.

**Visual Pressure Gauge:** Provides an intuitive view of the oil change system's working pressure status.

**Mechanical Pressure Adjustment Control:** Allows pressure adjustment via a knob to meet different vehicle requirements.

**High-Quality Materials:** Features corrosion-resistant, high-temperature, and oxidation-resistant aluminum alloy oil pipes.

**Wide Compatibility:** Equipped with 17 vehicle adapters; compatible with most vehicle models.

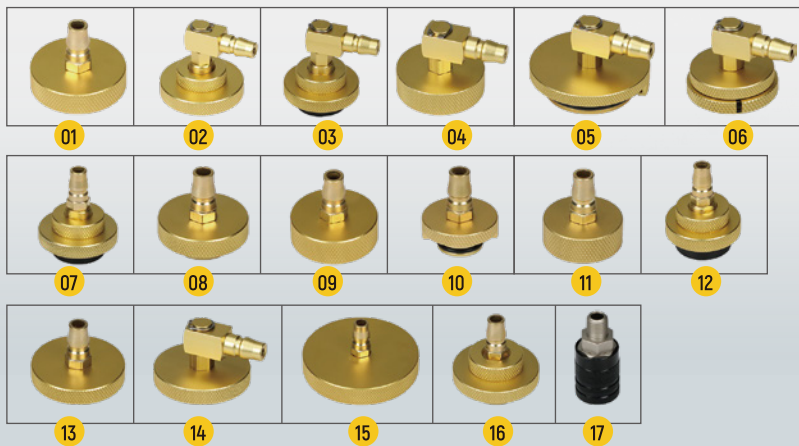

01	FOR Benz, FOR BMW, FOR Audi, FOR Skoda, FOR FIAT, FOR Lexus, FOR Ford, FOR Jaguar, FOR Land Rover, FOR Porsche, FOR Buick, FOR Chevrolet, FOR Volvo, FOR Citroen, FOR Volkswagen, FOR PEUGEOT, FOR Renault		
02	FOR Mitsubishi, FOR JAC, FOR Hyundai, FOR Infiniti, FOR Subaru, FOR Renault, FOR KIA series, FOR BAIC BJEV		
03	FOR Buick business series	04	FOR Ford Focus, FOR Ford edge, FOR Audi, FOR PEUGEOT
05	FOR Honda series	06	FOR Toyota series
07	FOR Cadillac, FOR Ford Fiesta, FOR Buick, FOR Mazda	08	FOR Dodge, FOR Chrysler, FOR JEEP series
09	FOR DONG FENG FENGXING Series	10	FOR Nissan Series
11	FOR WULING	12	FOR Changan Suzuki
13	FOR SOUEAST DX5, FOR DX7	14	FOR Teana, FOR Qashqai, FOR X-TRAIL(Nissan 2.0 and above)
15	FOR Mitsubishi, FOR SOUEAST, FOR LINGYUE		
16	FOR Tesla	17	Quick connector



One-click Exchange



Adjustable Pressure



Improve Efficiency



Widely Applicable



One-person Operation



Portable Design

Power Supply	AC 110V/220V	Filling Hose Length	3.5m
Max. Power	40W	Container Empty Protection	Yes
Output Pressure	0.7-3.0bar	Main Unit Dimensions	180x215x280mm
Maximum Output Flow Rate	1.6L/min	Packaging Dimensions	370x285x230mm

AST605

BRAKE FLUID BLEEDER





# BRAKE FLUID BLEEDER

The AUTOOL AST612 Brake Fluid Bleeder utilize a new pulsating technology for brake fluid replacement. It continuously applies pressure to the brake fluid pipelines in a pulse-like manner, effectively flushing the pipelines. This ensures a more thorough replacement of brake fluid, preventing the formation of air bubbles during the oil change and filling process, thereby optimizing or eliminating the need for manual air bleeding.

**Adopts New Pulsating Brake Fluid Exchange Technology:** Automatically removes air bubbles from the pipeline and cleans pipeline dirt, ensuring a more thorough oil change.

**Automated One-Click Oil Change:** Single-person operation, completes the oil change in 5 minutes with an oil change rate of over 98%.

**Automatic Pressure Relief Function:** Automatically relieves pressure when the machine stops to prevent brake fluid splashing.

**Visual Pressure Gauge:** Provides an intuitive view of the oil change system's working pressure status.

**Pressure Adjustment Button:** Allows for easy adjustment of oil change pressure by increasing or decreasing as needed.

**Two 1.5-Liter Recovery Bottles:** Enables simultaneous brake fluid changes on two wheels, significantly improving efficiency.

**Wide Compatibility:** Equipped with 17 types of adapters, suitable for most vehicles on the market.

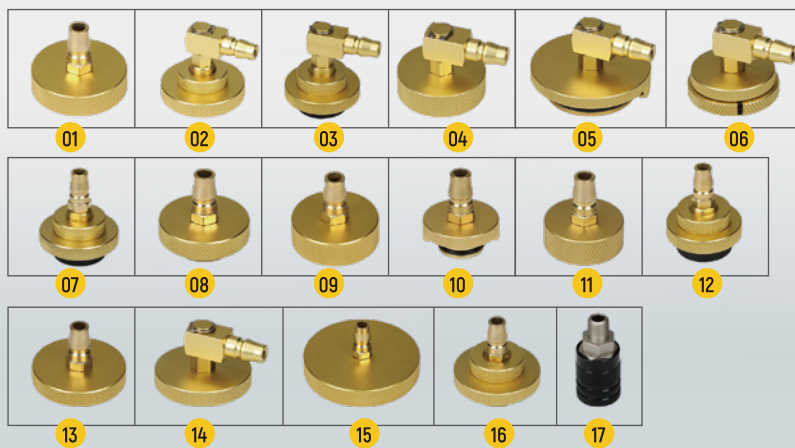

Pulsating Oil Exchanging



Fast & Efficient



One-person Operation



Widely Applicable



Pressure Release Design



Compact & Portable

01	FOR Benz, FOR BMW, FOR Audi, FOR Skoda, FOR FIAT, FOR Lexus, FOR Ford, FOR Jaguar, FOR Land Rover, FOR Porsche, FOR Buick, FOR Chevrolet, FOR Volvo, FOR Citroen, FOR Volkswagen, FOR PEUGEOT, FOR Renault		
02	FOR Mitsubishi, FOR JAC, FOR Hyundai, FOR Infiniti, FOR Subaru, FOR Renault, FOR KIA series, FOR BAIC BJEV		
03	FOR Buick business series	04	FOR Ford Focus, FOR Ford edge, FOR Audi, FOR PEUGEOT
05	FOR Honda series	06	FOR Toyota series
07	FOR Cadillac, FOR Ford Fiesta, FOR Buick, FOR Mazda	08	FOR Dodge, FOR Chrysler, FOR JEEP series
09	FOR DONG FENG FENGXING Series	10	FOR Nissan Series
11	FOR WULING	12	FOR Changan Suzuki
13	FOR SOUEAST DX5, FOR DX7	14	FOR Teana, FOR Qashqai, FOR X-TRAIL(Nissan 2.0 and above)
15	FOR Mitsubishi, FOR SOUEAST, FOR LINGYUE		
16	FOR Tesla	17	Quick connector

Power Supply	DC 12V/3A	Filling Hose Length	3.5m
Storage Bottle Capacity	1L	Adapter Fittings	17 types
Operating Pressure	1.5-3.0bar	Main Unit Dimensions	268x210x295mm
Maximum Output Flow Rate	2.6L/min	Packaging Dimensions	370x364x330mm



# PULSATING BRAKE & CLUTCH BLEEDER

The AUTOOL AST618 Pulsating Brake & Clutch Bleeder utilize a new pulsating technology for brake fluid replacement. It continuously applies pressure to the brake fluid pipelines in a pulse-like manner, effectively flushing the pipelines. This ensures a more thorough replacement of brake fluid, preventing the formation of air bubbles during the oil change and filling process, thereby optimizing or eliminating the need for manual air bleeding.

**Adopts New Pulsating Brake Fluid Exchange Technology:** Automatically removes air bubbles from the pipeline and cleans pipeline dirt, ensuring a more thorough oil change.

**Fully Automated One-Click Oil Change:** Single-person operation, efficient and quick, saving time and effort while improving work efficiency.

**Automatic Pressure Relief Function:** Automatically relieves pressure when the machine stops to prevent brake fluid splashing.

**Visual Pressure Gauge:** Provides an intuitive view of the oil change system's working pressure status.

**Smart Control Panel:** Allows precise settings for working pulse, pressure, and time.

**Simultaneous Four-Wheel Oil Change:** Can change brake fluid on all four wheels at once, doubling efficiency.

**3-Liter Large Capacity Oil Tank:** Made from high-quality stainless steel, offering corrosion resistance, impact resistance, and oxidation resistance.

**Portable Integrated Design:** Equipped a three-stage telescopic handle and external 360° rotating wheels, suitable for various work environments.

**Wide Compatibility:** Equipped with 17 types of adapters, suitable for most vehicles on the market.



01	FOR Benz, FOR BMW, FOR Audi, FOR Skoda, FOR FIAT, FOR Lexus, FOR Ford, FOR Jaguar, FOR Land Rover, FOR Porsche, FOR Buick, FOR Chevrolet, FOR Volvo, FOR Citroen, FOR Volkswagen, FOR PEUGEOT, FOR Renault		
02	FOR Mitsubishi, FOR JAC, FOR Hyundai, FOR Infiniti, FOR Subaru, FOR Renault, FOR KIA series, FOR BAIC BJEV		
03	FOR Buick business series	04	FOR Ford Focus, FOR Ford edge, FOR Audi, FOR PEUGEOT
05	FOR Honda series	06	FOR Toyota series
07	FOR Cadillac, FOR Ford Fiesta, FOR Buick, FOR Mazda	08	FOR Dodge, FOR Chrysler, FOR JEEP series
09	FOR DONG FENG FENGXING Series	10	FOR Nissan Series
11	FOR WULING	12	FOR Changan Suzuki
13	FOR SOUEAST DX5, FOR DX7	14	FOR Teana, FOR Qashqai, FOR X-TRAIL(Nissan 2.0 and above)
15	FOR Mitsubishi, FOR SOUEAST, FOR LINGYUE		
16	FOR Tesla	17	Quick connector



Pulsating Oil Exchanging



Widely Applicable



One-person Operation



Intelligent Adjustment



Pressure Display



Trolley Design

AST618

PULSATING BRAKE & CLUTCH BLEEDER

Power Supply	DC 12V/3A	Adapters	17 types
Brake Fluid Capacity	3L	Pressure Bleed Time After Stopping	10S
Operating Pressure	0.6-3.0bar	Supported Simultaneous Exchange	4 Brake Cylinders
Max. Output Flow Rate	1.6L/min	Gross Weight / Net Weight	24.5kg/22.5kg
Main Unit Size			515x438x550mm





**AUTOOL**

RELIABLE TOOLS FOR  
RELIABLE REPAIRS



# AUTOMOTIVE STABILIZED POWER SUPPLY

The AUTOOL Automotive Stabilized Power Supply features functions such as jump start, charging, and battery restoration. It can be used not only for stabilizing voltage during software upgrades and programming of automotive electronic control modules but also serves as a charger through mode switching, providing charging and auxiliary starting for 12V vehicles, 24V trucks, or 48V mild hybrid lithium batteries. Additionally, it functions as a power supply device for automotive maintenance and debugging purposes.

PR420

42

PR430

43

PR460

44



PR420

# AUTOMOTIVE STABILIZED POWER SUPPLY

**Programmable Power Supply Mode:** Precisely set the voltage range to provide a stable voltage source, ensuring accurate data transmission during ECU system programming and decoding operations.

**Multi-stage Smart Charging Mode:** smartly adjusts charging power for optimal charging effect.

**Battery Restoration Function:** Uses advanced pulse restoration technology to quickly fix battery issues and restore the battery to its usable state.

**Vehicle Display Mode:** Uninterrupted power supply supports simultaneous charging and discharging, also serving as a stable external power source for vehicle exhibitions.

The AUTOOL PR420 Automotive Stabilized Power Supply features functions such as forced start, charging, and battery restoration. It can be used not only for stabilizing voltage during software upgrades and programming of automotive electronic control modules but also serves as a charger through mode switching, providing charging, repairing, and auxiliary starting for 12V vehicles. Additionally, it functions as a power supply device for automotive maintenance and debugging purposes.



Programming Power



Fast Charging



Vehicle Forced Start



Battery Restoration



Multi-Protection



Lightweight & Portable

Suitable for 12V/24V Batteries:



Applicable Battery Types:



High-speed Cooling Fan

## MULTI-STAGE SMART CHARGING

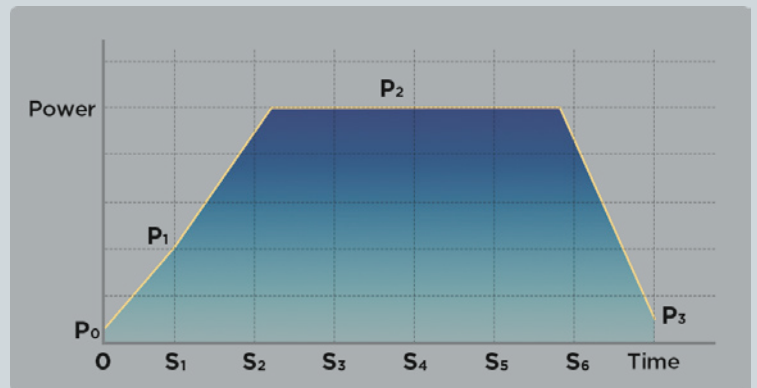

**AUTOMOTIVE STABILIZED POWER SUPPLY**

**WARNING**

- Rechargeable batteries only. Disposable batteries are prohibited.
- As charging generates flammable gases, open flames are strictly prohibited in the operating area.
- Keep out of reach of children. Ensure proper grounding to prevent shock.
- Use restoration mode cautiously, as it may lead to electrolyte loss or drying of the cell.

PREVENT ELECTRIC LEAKAGE  
 READ THE MANUAL  
 WEAR INSULATING GLOVES  
 KEEP DRY  
 GROUNDING REQUIRED  
 NO OPEN FLAMES  
 CHILDREN FORBIDDEN

Rated Input Voltage	AC 110V or AC 220V	Supply Current	120A
Input Frequency	50Hz/60Hz	No-Load Power Loss	6W
Rated Input Power	1200W	Efficiency	81%
Supply Voltage Range	10.8V-16V	Insulation Grade	F
Charging Current/Voltage	20A / 12V	Enclosure Protection Level	IP21S





# AUTOMOTIVE STABILIZED POWER SUPPLY



High-speed Cooling Fan

The AUTOOL PR430 Automotive Stabilized Power Supply features functions such as forced start, charging, and battery restoration. It can be used not only for stabilizing voltage during software upgrades and programming of automotive electronic control modules but also serves as a charger through mode switching, providing charging, repairing, and auxiliary starting for 12V vehicles. Additionally, it functions as a power supply device for automotive maintenance and debugging purposes.

**Programmable Power Supply Mode:** Precisely set the voltage range to provide a stable voltage source, ensuring accurate data transmission during ECU system programming and decoding operations.

**Multi-stage Smart Charging Mode:** smartly adjusts charging power for optimal charging effect.

**Battery Restoration Function:** Uses advanced pulse restoration technology to quickly fix battery issues and restore the battery to its usable state.

**Vehicle Display Mode:** Uninterrupted power supply supports simultaneous charging and discharging, also serving as a stable external power source for vehicle exhibitions.

**Vehicle Emergency Start:** Provides 400A high cranking current, easily starting car engines below 3.0L displacement.



Programming Power



Fast Charging



Vehicle Forced Start



Battery Restoration



Multi-Protection



Lightweight & Portable

## MULTI-STAGE SMART CHARGING

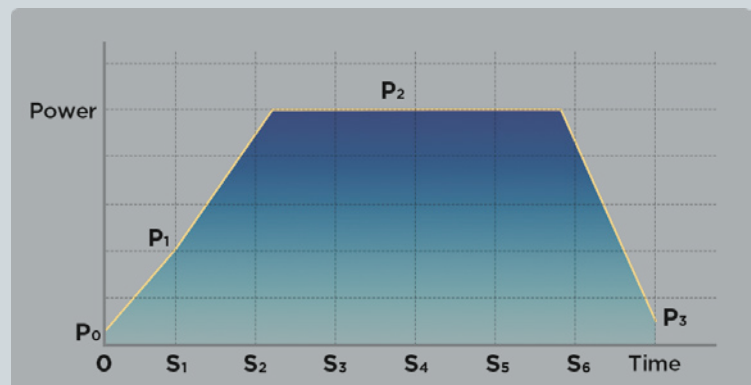

Suitable for 12V/24V Batteries:



Applicable Battery Types:



Applicable Lithium Battery Types:



Rated Input Voltage	AC 110V or AC 220V	Lead-Acid Battery Charging Current/Voltage	40A / 12V
Input Frequency	50Hz/60Hz	Lithium Battery Charging Current/Voltage	20A / 12V
Rated Input Power	1500W	Supply Current	150A
Cranking Current/Voltage	400A / 12V	No-Load Power Loss	6W
Supply Voltage Range	9V-16V	Enclosure Protection Level	IP21S



PR460

AUTOOOL

44

# AUTOMOTIVE STABILIZED POWER SUPPLY

The AUTOOL PR460 Automotive Stabilized Power Supply features functions such as forced start, charging, and battery restoration. It can be used not only for stabilizing voltage during software upgrades and programming of automotive electronic control modules but also serves as a charger through mode switching, providing charging and auxiliary starting for 12V vehicles (including lithium batteries). Additionally, it functions as a power supply device for automotive maintenance and debugging purposes.



**Programmable Power Supply Mode:** Precisely set the voltage range to provide a stable voltage source, ensuring accurate data transmission during ECU system programming and decoding operations.

**Multi-stage Smart Charging Mode:** smartly adjusts charging power for optimal charging effect.

**Battery Restoration Function:** Uses advanced pulse restoration technology to quickly fix battery issues and restore the battery to its usable state.

**Vehicle Display Mode:** Uninterrupted power supply supports simultaneous charging and discharging, also serving as a stable external power source for vehicle exhibitions.

**Vehicle Emergency Start:** Provides 400A high cranking current, easily starting car engines below 3.0L displacement.

**Adjustable Charging Power Supply:** Adapts to the charging needs of various devices by flexibly adjusting the output voltage and current, providing reliable testing for different electrical accessories.



Programming Power



Fast Charging



Vehicle Forced Start



Battery Restoration



Multi-Protection



Lightweight & Portable

Suitable for 12V/24V Batteries:

12V

24V

48V

Applicable Battery Types:

FLOODED REGULAR

AGM SPIRAL

AGM FLAT

EFB

GEL

Applicable Lithium Battery Types:

NCM

LFP



Providing Reliable Testing For Different Electrical Accessories.



Rated Input Voltage	AC 110V or AC 220V	Lead-Acid Battery Charging Current/Voltage	40A / 12V
Input Frequency	50Hz/60Hz	Lithium Battery Charging Current/Voltage	20A / 12V
Rated Input Power	1500W	Supply Current	150A
Cranking Current/Voltage	400A / 12V	Supply Voltage Range	9V-16V
Adjustable Power Supply Current/Voltage			20A/3V-8.9V, 100A/9V-16V

AUTOMOTIVE STABILIZED POWER SUPPLY



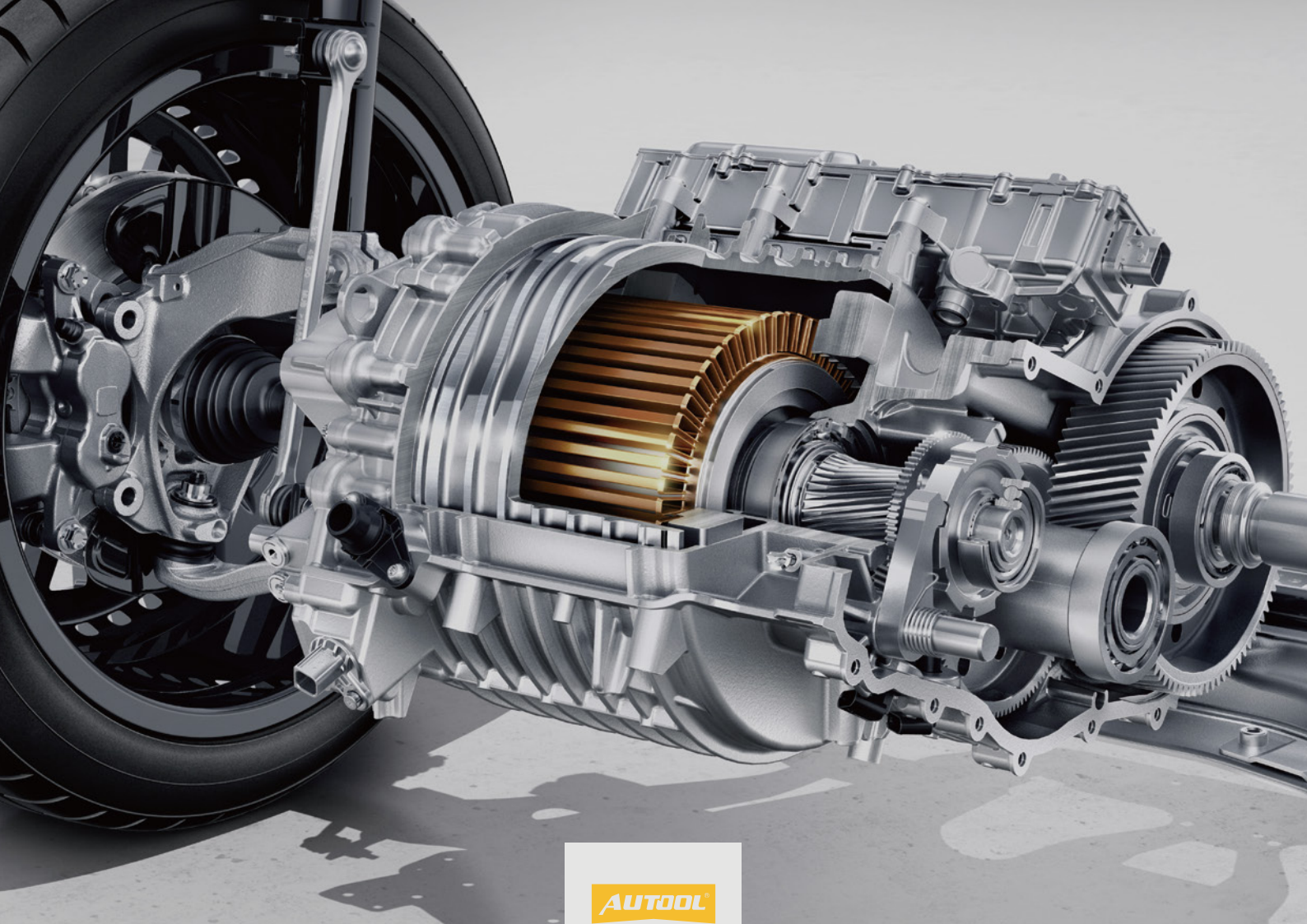

**AUTOOL**

RELIABLE TOOLS FOR  
RELIABLE REPAIRS



# TRANSMISSION FLUID EXCHANGER

The AUTOOL Automatic Transmission Fluid Exchanger series is primarily designed for exchanging transmission fluid in automobiles. It recovers & measures the used fluid while simultaneously filling the same amount of new fluid into the vehicle. This process is completed rapidly and automatically, enhancing efficiency and work quality during fluid exchange. Additionally, it reduces damage and contamination associated with manual operation, serving as a equipment to maintain consistent fluid levels during automatic transmission fluid exchange in vehicles.

ATF802

46

ATF805

47



# AUTO ATF EXCHANGER



The AUTOOL ATF802 Auto ATF Exchanger is primarily designed for exchanging transmission fluid in automobiles. It recovers & measures the used fluid while simultaneously filling the same amount of new fluid into the vehicle. This process is completed rapidly and automatically, enhancing efficiency and work quality during fluid exchange. Additionally, it reduces damage and contamination associated with manual operation, serving as a equipment to maintain consistent fluid levels during automatic transmission fluid exchange in vehicles.

Fully automatic recognition of oil inlet and outlet direction: Automatically and intelligently switches between the oil inlet and outlet directions for automatic transmissions without requiring operator judgment.

Fully automatic replacement of used and new oil: Supports automatically complete high-precision equal amount flushing and oil exchange for transmissions, torque converters, and transmission coolers within 15 minutes, achieving an oil exchange rate close to 100%.

Intelligent electronic control for equal exchange: Achieves high-precision equal exchange of new and used oil, ensuring the quality of oil exchange for automotive automatic transmissions.

Automatic circulation cleaning: Performs circulation cleaning on the automatic transmission to remove internal impurities, improve transmission performance, and extend its service life.

Automatic filling and draining of oil: Can automatically fill the transmission with oil as well as reduce the oil volume in the transmission.

Intuitive oil pressure display: Real-time display of transmission cooler oil pressure, allowing operators to easily monitor the working status.

LCD display and user-friendly operation: Features a 5-inch color LCD screen with convenient and practical button controls.

Compatible with various vehicle models: Equipped with a range of specialized connectors, suitable for different vehicle models from Europe, America, Asia, and other regions.



ATF802

TRANSMISSION FLUID EXCHANGER



Automatic Equal Exchange



Circulating Cleaning



Oil Level Display



Widely Use



Pressure Display



Easy to Move

## Accessories

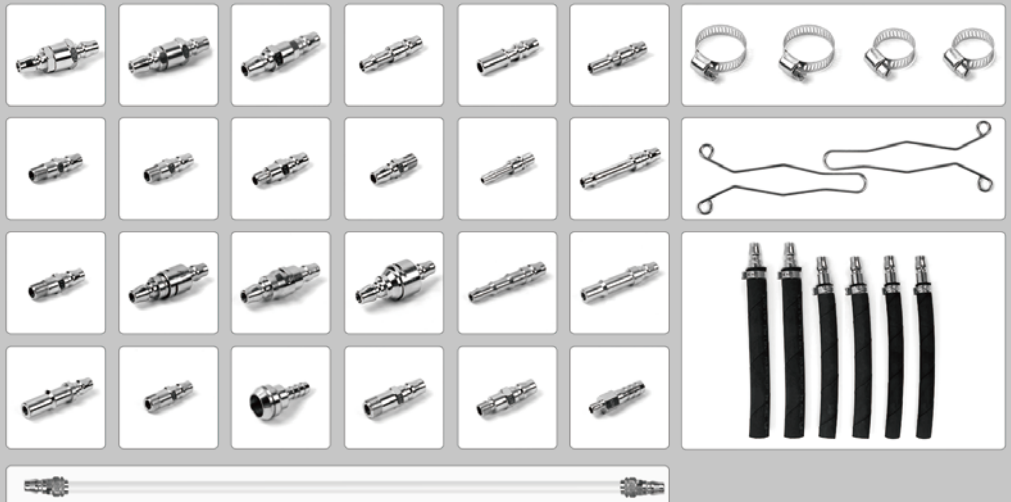

Power Supply	AC 100~240V	Oil Tank Volume	25L
Rated Power	300W	Display Screen	5-inch
System Pressure	0~15kg/cm <sup>2</sup>	Equal Volume Exchange Error	<0.2kg
Oil Outlet Hose	2.5m	Relative Humidity	<85%
Return Oil Hose	2.5m	Product Size	533x526x1143mm





# AUTO ATF EXCHANGER



The AUTOOL ATF805 Auto ATF Exchanger is primarily designed for exchanging transmission fluid in automobiles. It recovers & measures the used fluid while simultaneously filling the same amount of new fluid into the vehicle. This process is completed rapidly and automatically, enhancing efficiency and work quality during fluid exchange. Additionally, it reduces damage and contamination associated with manual operation, serving as a equipment to maintain consistent fluid levels during automatic transmission fluid exchange in vehicles.

Fully automatic recognition of oil inlet and outlet direction: Automatically and intelligently switches between the oil inlet and outlet directions for automatic transmissions without requiring operator judgment.

Fully automatic replacement of used and new oil: Supports automatically complete high-precision equal amount flushing and oil exchange for transmissions, torque converters, and transmission coolers within 15 minutes, achieving an oil exchange rate close to 100%.

Intelligent electronic control for equal exchange: Achieves high-precision equal exchange of new and used oil, ensuring the quality of oil exchange for automotive automatic transmissions.

Automatic circulation cleaning: Performs circulation cleaning on the automatic transmission to remove internal impurities, improve transmission performance, and extend its service life.

Automatic filling and draining of oil: Can automatically fill the transmission with oil as well as reduce the oil volume in the transmission.

Intuitive oil pressure display: Real-time display of transmission cooler oil pressure, allowing operators to easily monitor the working status.

LCD display and user-friendly operation: Features a 7-inch color LCD screen with convenient and practical button controls.

Compatible with various vehicle models: Equipped with a range of specialized connectors, suitable for different vehicle models from Europe, America, Asia, and other regions.

Automotive data query: Automatically queries relevant data such as oil exchange volume and operating procedures for the vehicle.

Equipped with a temperature sensor to measure the working oil temperature and circulate the new oil, heating it to above 20°C before adding it.



## Accessories

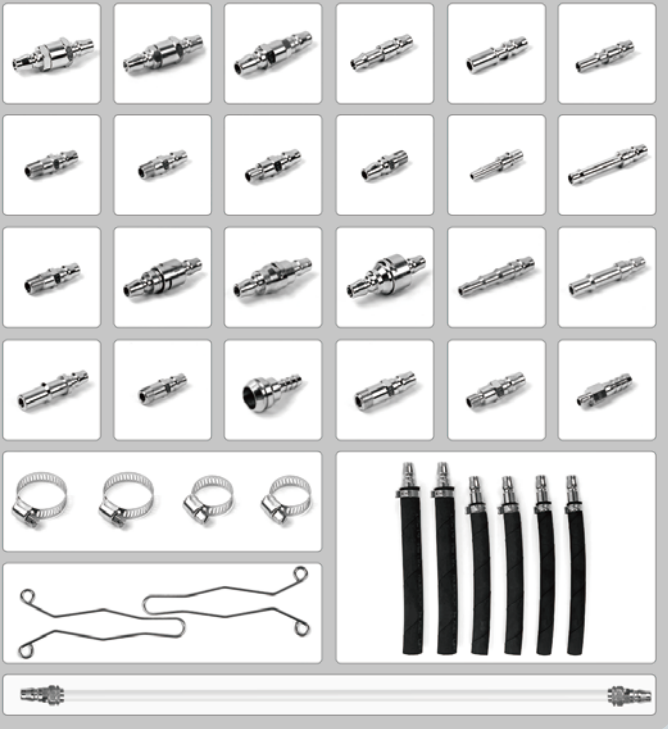

Automatic Equal Exchange



Circulating Cleaning



Identify The Oil Flow Direction Automatically



Identify Power Polarity Automatically



Widely Use



LCD Display

Power Supply	AC 100~240V	Oil Tank Volume	25L
Rated Power	300W	Display Screen	7-inch
System Pressure	0~15kg/cm <sup>2</sup>	Equal Volume Exchange Error	<0.2kg
Oil Outlet Hose	2.5m	Relative Humidity	<85%
Return Oil Hose	2.5m	Product Size	533x526x1143mm



**AUTOOL**

RELIABLE TOOLS FOR  
RELIABLE REPAIRS



# COOLING SYSTEM TESTER & FILLER

The AUTOOL Automotive Cooling System Tester and Filler is a device used in automotive maintenance and repair. It is designed to test for leaks in the cooling system by drawing a vacuum and pressurizing, as well as for filling the cooling fluid. With a high degree of automation, it can be operated by a single person, making it convenient, time-saving, and labor-saving. It effectively assists users in understanding the status of the automotive cooling system and provides corresponding maintenance solutions.

SC301

49

SC501

50





# COOLING SYSTEM TESTER & FILLER

The AUTOOL SC301 Automotive Cooling System Tester and Filler is a device used in automotive maintenance and repair. It is designed to test for leaks in the cooling system by drawing a vacuum and pressurizing, as well as for filling the cooling fluid. With a high degree of automation, it can be operated by a single person, making it convenient, time-saving, and labor-saving. It effectively assists users in understanding the status of the automotive cooling system and provides corresponding maintenance solutions.

**Fully Automated Operation:** Combines vacuuming the cooling system, pressure leak testing, and coolant filling into one equipment.

**Wide Compatibility:** Includes three types of conical adapters, covering most vehicles in Europe, America, and Asia.

**Three Pressure Settings:** Adjustable to -35KPa, -40KPa, or -45KPa for precise pressure values.

**Digital Display Window:** Intuitively and clearly shows the data.

**Safety Protection Feature:** Automatically stops and proceeds to the next step once the vacuum reaches a set pressure, preventing damage to the vehicle's cooling system.

**Liquid Drainage Design:** Allows for the drainage of residual coolant from internal pipes at the end of the operation, ensuring safety and reliability.



Cooling System Vacuum



Coolant Filling



Pressure Leak Detection



3 Pressure Modes



Digital Display



Pressure Protection Design



## Adapter Fittings

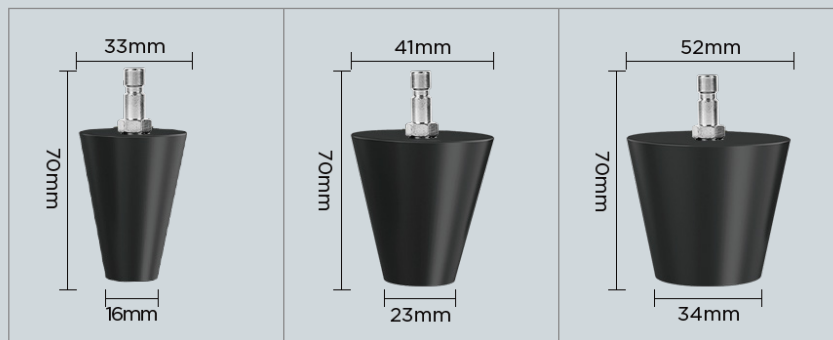

Power Supply	DC 12V	Length of Air Output Tube	1m
Pressure Range	-1~2bar	Length of Fluid Input Tube	0.5m
Operating Temperature	-10°C~60°C	Package Weight	7.2kg
Length of Refilling Tube	2m	Package Dimensions	370x310x416mm

# COOLING CLEANING & CHANGING MACHINE

The AUTOOL SC501 Cooling Cleaning & Changing Machine combines cooling system flushing and automatic coolant refill functions into one machine. With a high degree of automation, the machine can be operated by a single person, making it convenient, time-saving, and labor-saving. It effectively assists users in understanding the status of the automotive cooling system and provides corresponding maintenance solutions.

**One-Click fully automatic replacement:** automatically replacing vehicle coolant without manual operation, improving work efficiency.

**Precise control:** Accurately controls coolant flow and pressure during the replacement process to ensure accuracy and prevent damage to the cooling system.

**Cleaning function:** Performs circulation cleaning of the cooling system to effectively remove scale, rust, and other impurities, enhancing cooling performance and extending the system's service life.

**New and old liquid visible comparison:** Equipped with transparent window pipelines for easy observation of the comparison between new and old liquids, ensuring thorough coolant replacement.

**Compatible with various vehicle models:** Equipped with multiple connectors to fit most vehicle cooling systems on the market.

**Safety protection:** Features overpressure protection to prevent damage to the vehicle's cooling system from excessive pressure, and an automatic collection system in the old liquid tank to prevent overflow.

**Easy operation:** The interface is simple and clear, making it easy to use without the need for special training.

**Real-time fluid level display:** Provides real-time display of new and old coolant levels.

**Quiet operation:** Designed to operate with minimal noise.

**Vacuum pressure retention mode:** Before filling, the coolant can be evacuated to create a vacuum. The pressure is then maintained to check for any leaks in the cooling system.



One-click Fully Automatic Replacement



LCD Display



New and Old Liquid Visible Comparison



Widely Applicable



Quiet Operation



Cleaning Function

Power Supply	AC 100-240V	System Pressure	0-3.5kg/cm <sup>2</sup>
Rated Power	150W	Output Hose Length	3m
Liquid Tank Capacity	20L	Return Hose Length	3m
Main Unit Dimensions	533x526x1143 mm		





**AUTOOL**

RELIABLE TOOLS FOR  
RELIABLE REPAIRS



# SMART DIGITAL MANIFOLD GAUGE

The AUTOOL automotive smart digital manifold gauge features a unique integrated appearance, multi-function operation panel, and innovative and advanced detection technology, providing users with a brand-new experience. This series of products offers comprehensive features including pressure testing, digital readouts, multi-unit switching, diverse operational modes, and a comprehensive refrigerant parameter database. It serves as an indispensable auxiliary tool for the installation, diagnostics, and maintenance of automotive air conditioning systems and other refrigeration equipment, embodying excellence in automotive servicing instrumentation.

LM160	52
LM180	53
LM180 PRO	54



# LM160

AUTOOL

52

# SMART DIGITAL MANIFOLD GAUGE



The AUTOOL LM160 automotive smart digital manifold gauge features a unique integrated appearance, multi-function operation panel, and innovative and advanced detection technology, providing users with a brand-new experience. This series of products offers comprehensive features including pressure testing, digital readouts, multi-unit switching, diverse operational modes, and a comprehensive refrigerant parameter database. It serves as an indispensable auxiliary tool for the installation, diagnostics, and maintenance of automotive air conditioning systems and other refrigeration equipment, embodying excellence in automotive servicing instrumentation.

**Versatile Use:** Three modes for easy switching—refrigeration testing, leak detection, and vacuuming.

**High Precision Sensor:** Includes temperature compensation with a measurement range from 0 bar to 60 bar, real-time temperature display.

**Built-in data** for 95 types of refrigerants, suitable for 99% of automotive refrigerant systems on the market.

**Smart Control System:** Digital display for results, simplifying complex processes for intuitive and easy use.

**Durable and Reliable:** Made with engineering silicone and aluminum alloy valve body, resistant to corrosion and wear.

**Backlight Screen:** High-definition 2.8-inch LCD backlit display, allowing operation in dark environments and meeting various needs.

**Time-Saving Design:** Features include a folding hook, side handles, high/low pressure valves, and a refrigerant observation window.

**Multiple Units:** Easily switch between two temperature units (Celsius °C / Fahrenheit °F), three vacuum units (hPa, mbar, Torr), and five pressure units (bar, kgf/cm<sup>2</sup>, psi, kPa, MPa).

LM160

SMART DIGITAL MANIFOLD GAUGE



Three-Color Hoses Set



Low/High-Pressure Hose Valve Connector



Temperature Clamps



Evacuation Mode



Refrigerant Mode



Pressure Leak Test



Various Units Available



Built-in 95 Refrigerant Types

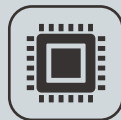

Program Control System

Operating Voltage	6V (4 AA batteries)	Vacuum Range	-14.7~0psi, -1~0bar
Pressure Units	psi, kPa, MPa, bar, kg/cm <sup>2</sup>	Pressure Resolution	0.1psi, 0.01bar, 0.005Mpa
Temperature Units	°C, °F	Temperature Resolution	0.1°C, 0.1°F
Vacuum Units	Micron, hPa, mbar, mTorr, Torr	Vacuum Resolution	1Micron, 1Torr, 1mbar
Pressure Range	0~870psi	Overload Capacity	942.5psi, 65bar, 6.5Mpa
Temperature Range	-55°C~125°C(-67°F~257°F)	Pressure Accuracy	±0.5% of full range





# DIGITAL MANIFOLD GAUGE

The AUTOTOL LM180 automotive smart digital manifold gauge features a unique integrated appearance, multi-function operation panel, and innovative and advanced detection technology, providing users with a brand-new experience. This series of products offers comprehensive features including pressure testing, digital readouts, multi-unit switching, diverse operational modes, and a comprehensive refrigerant parameter database. It serves as an indispensable auxiliary tool for the installation, diagnostics, and maintenance of automotive air conditioning systems and other refrigeration equipment, embodying excellence in automotive servicing instrumentation.



**Versatile Use:** Five modes for easy switching—refrigeration testing, leak detection, vacuuming, compressor testing mode, and temperature difference mode.

**High Precision Sensor:** Includes temperature compensation with a measurement range from 0 bar to 60 bar, real-time temperature display.

**Built-in data** for 92 types of refrigerants, suitable for 99% of automotive refrigerant systems on the market.

**Bluetooth Wireless Connection:** Real-time data monitoring on your smartphone.

**Smart Control System:** Digital display for results, simplifying complex processes for intuitive and easy use.

**Durable and reliable,** made with engineering-grade silicone and alloy valve bodies, resistant to corrosion and wear.

**Clear Interface:** High-definition 4-inch LCD backlit display, allowing operation in dark environments and meeting various needs.

**Time-saving and labor-efficient,** with detailed design including a folding hook, side handles, high/low pressure valves, and dual refrigerant observation windows.

**Multiple Units:** Easily switch between three vacuum units (hPa, mbar, Torr) and five pressure units (bar, kg/cm<sup>2</sup>, psi, kPa, MPa).

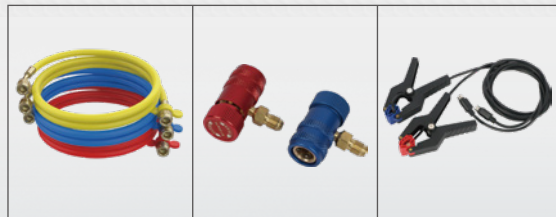

Three-Color Hoses Set

Low/High-Pressure Hose Valve Connector

Temperature Clamps



Evacuation Mode



Refrigerant Mode



Pressure Leak Test



Various Units Available



Built-in 92 Refrigerant Types

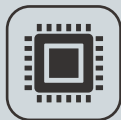

Program Control System



Foldable hook

Refrigerant visible window

Two-side handrails

<b>Operating Voltage</b>	7.5V (5 AA batteries) / DC 12V	<b>Vacuum Range</b>	-14.7psi-0psi, -1-0bar
<b>Pressure Units</b>	psi, kPa, MPa, bar, kg/cm <sup>2</sup>	<b>Pressure Resolution</b>	0.1psi, 0.01bar, 0.005Mpa
<b>Vacuum Units</b>	hPa, mbar, Torr	<b>Vacuum Resolution</b>	1Micron, 1Torr, 1mbar
<b>Pressure Range</b>	0-870psi	<b>Overload Capacity</b>	942.5psi, 65bar, 6.5Mpa



## DIGITAL MANIFOLD GAUGE

The AUTOOL LM180 PRO Digital Manifold Gauge features a unique integrated design, an intelligent display interface, and a multifunctional control panel. Through meticulous craftsmanship and advanced technology, it delivers a new experience in automotive air conditioning refrigerant measurement. This series of products offers comprehensive features including pressure testing, digital display, multi-unit switching, diverse operational modes, multi-manifold valve bodies, and a comprehensive refrigerant parameter database. It serves as an auxiliary measurement instrument for the installation, testing, and maintenance of automotive air conditioning and other cooling equipment.

**Versatile Use:** Five modes for easy switching—refrigeration testing, leak detection, vacuuming, compressor testing mode, and temperature difference mode.

**High Precision Sensor:** Includes temperature compensation with a measurement range from 0 bar to 60 bar. It can connect to dual temperature clamps to display current temperature values in real time.

**Built-in data for 95 types of refrigerants,** covering most automotive refrigerant systems on the market.

**Bluetooth wireless connection** allows for real-time data monitoring via a mobile app, and can connect to a Bluetooth temperature clamp as needed for temperature testing.

**Smart Control System:** Digital display for results, simplifying complex processes for intuitive and easy use.

**Durable and reliable,** featuring pure copper connectors and an aluminum alloy valve body, which are resistant to corrosion and wear.

**Clear interface** with a HD 4-inch LCD backlit display, ensuring visibility in various environments.

**Time-saving and labor-saving design** with features such as a foldable hook, side handles, and dual refrigerant observation windows.

**Separate connections** for high-pressure, low-pressure, filling, and vacuum pump hoses connectors, allowing precise control of each function and improving operational efficiency.

**Multiple unit options** with easy switching: six vacuum units and six pressure units.



LM180 PRO

DIGITAL MANIFOLD GAUGE

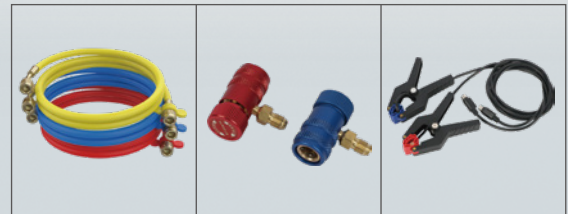

Three-Color Hoses Set

Low/High-Pressure Hose Valve Connector

Temperature Clamps



Evacuation Mode



Refrigerant Mode



Pressure Leak Test



Various Units Available



Built-in 95 Refrigerant Types

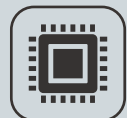

Program Control System

Operating Voltage	7.5V (5 AA batteries) / DC 12V	Measurement Accuracy	±0.5%
Pressure Range	0-60bar	Number of Manifold Connectors	4
Temperature Range	0-85°C	Languages	13
Vacuum Range	-1-0bar	Built-in Refrigerant Types	95





**AUTOOL**  
RELIABLE TOOLS FOR  
RELIABLE REPAIRS



# REFRIGERANT RECOVERY MACHINE

The AUTOOL Refrigerant Recovery Machine is an all-in-one, fully automated and intelligent equipment that integrates functions such as refrigerant recovery, vacuum pumping, oil filling, and refrigerant charging. With a user-friendly interface, reliable manufacturing process, and advanced technological principles, it is a highly recommended choice for automotive air conditioning maintenance.

LM707	56
LM708	57



# REFRIGERANT RECOVERY MACHINE

The AUTOOL LM707 Refrigerant Recovery Machine is an all-in-one, fully automated and intelligent equipment that integrates functions such as refrigerant recovery, vacuum pumping, oil filling, and refrigerant charging. With a user-friendly interface, reliable manufacturing process, and advanced technological principles, it is a highly recommended choice for automotive air conditioning maintenance.



Automatic operation: the parameters can be set in advance and then the equipment automatically completes the refrigerant replacement work.

Large capacity internal tank: it can store up to 12kg of refrigerant, and can continuously replace refrigerant for dozens of vehicles.

Built-in high-precision electronic scale can accurately measure the weight of refrigerant and realize quantitative recovery and refilling of refrigerant.

Suitable for fuel vehicles, hybrid vehicles, or new energy vehicle.

Equipped with two 350ml oil bottles, which can be used to drain used-oil and refilling with new oil.

Refrigerant cleaning: the recovered refrigerant can be reused through the built-in filter and separator.



Refrigerant Hoses (1 red and 1 blue)



High Pressure Refrigerant Quick Connector



Low Pressure Refrigerant Quick Connector



Refrigerant Recovery



Vacuuming



Refrigerant Refill



Refrigerant Charging



Refrigerant Cleaning



Auto Mode

Power Supply	AC 110V/220V	Internal Tank Capacity	12kg
Power Rating	800W	New Oil Bottle Capacity	350ml
Applicable Refrigerant Type	R134a	Used Oil Bottle Capacity	350ml
Operating Ambient Temperature	10°C-50°C	Recharging Rate	800-1200g/min
Electronic Scale Accuracy	±10g	Display Screen	5-inch Display
Recovery Capacity	200-350g/min	Product Weight	86kg
Vacuum Pump Capacity	5Pa	Product Size	545x610x973mm





# REFRIGERANT RECOVERY MACHINE

The AUTOOL LM708 Refrigerant Recovery Machine is an all-in-one, fully automated and intelligent equipment that integrates functions such as refrigerant recovery, vacuum pumping, oil filling, and refrigerant charging. With a user-friendly interface, reliable manufacturing process, and advanced technological principles, it is a highly recommended choice for automotive air conditioning maintenance.

Compatible with R134a and 1234yf refrigerants for vehicle air conditioner repair and maintenance.

Automatically performs recovery, vacuuming, recharging, and leak detection for R134a and 1234yf refrigerants.

Suitable for gasoline, diesel, hybrid, and pure electric vehicles.

Automatically cleans internal hoses to prevent mixing of different refrigerants and compressor oils.

Enhanced deep recovery function increases recovery efficiency to over 95%.

Equipped with five high-precision electronic scales for accurately weighing the internal tank storing R134a refrigerant, the internal tank storing 1234yf refrigerant, PAG, POE, and waste oil.

Offers three recharging methods: HP, LP, and HP+LP.

Built-in refrigerant database with over 20,000 models, allowing for customization.

Equipped with a printer for maintenance data printing as needed.

Powerful query functions provide access to operation records at anytime.



Refrigerant Hoses (1 red and 1 blue)

High Pressure Refrigerant Quick Connector

Low Pressure Refrigerant Quick Connector



High Pressure Refrigerant Quick Connector

Low Pressure Refrigerant Quick Connector



Dual systems



Vacuuming



Refrigerant Recovery & Refill



Built-in Database



Refrigerant Cleaning



7-inch Touch Screen



Intelligent Control Panel

Power Supply	AC 110V/220V	Internal Tank Capacity	15kg ( 2 Units )
Power Rating	1100W	Recovery Capacity	3/8HP
Applicable Refrigerant Type	R134a/1234yf	Recovery Efficiency	>95%
Operating Ambient Temperature	-20°C-60°C	Vacuuming Capacity	180L/min ( Bipolar )
Electronic Scales	5 Units	Oil Bottles	3 Units of 350ml Each ( PAG/POE/Waste Oil )
Electronic Scale Accuracy	±10g	Display Screen	7-inch Touch Screen
Filter Processing Capacity	100kg	Product Size	708x645x1106mm



**AUTOOL**

RELIABLE TOOLS FOR  
RELIABLE REPAIRS



# MAINTENANCE TOOL STORAGE SERIES

AUTOOL's maintenance tool storage series are designed to help you organize your cluttered tools, optimize space utilization, and easily locate necessary items, thereby enhancing the tidiness of your workshop.

T20 / T21	59
T22 / T23 / T25 / T26	60-61
T43	62





# AUTOMOTIVE SERVICE CART

The AUTOOL Automotive Service Cart is a versatile, specialized cart designed to store automotive diagnostic computers, programming power supplies, spare parts, and batteries in one unit. It helps you optimize space and quickly organize essential equipment, making the workstations more tidy and efficient.



## T20

(For Brake Fluid Bleeder)



## T21

(For Fuel Injector Cleaner & Tester)



Multi-layer Storage Design



Sturdy & Durable



Rust & Corrosion Resistant



High-quality Material



360° Rotation Casters

**Layered Storage Design:** It includes designated layers for placing laptops, programming power supplies, diagnostic devices, and batteries.

**Heavy-Duty Steel Construction:** Forged from heavy duty steel, the cart exhibits strong resilience, lasting durability, and resistance to deformation.

**Powder Coating Surface:** The surface is treated with a powder coating, providing excellent rust and corrosion resistance.

**360° Universal Casters:** Made from natural rubber, the wheels ensure good noise reduction and minimize floor friction, allowing for easy movement.

**Stainless Steel Handrails:** The handrails are made from selected stainless steel materials, offering a smooth and shiny appearance that resists corrosion.

Model	T20	T21
Weight	23kg	27.5kg
Dimensions	44x74x100mm	44x74x100mm
Material	Cold Rolled Steel Plate	Cold Rolled Steel Plate
Plate thickness	Bottom plate 3.0mm, Layers 1.5mm, Columns 1.5mm	Bottom plate 3.0mm, Layers 1.5mm, Columns 1.5mm
Load Capacity	≤300kg	≤300kg



T22 / T23 / T25 / T26

The AUTOOL Rolling Utility Cart is a versatile, specialized cart designed to store automotive diagnostic computers, programming power supplies, spare parts, and batteries in one unit. It helps you optimize space and quickly organize essential equipment, making the workstations more tidy and efficient.



### T22



Multi-layer Storage Design



High-quality Material



Rust & Corrosion Resistant



360° Rotation Casters

### T23



Multi-layer Storage Design



High-quality Material



Lockable Drawer



Rotating Lift Workbench

### T25



Multi-layer Storage Design



High-quality Material



Rust & Corrosion Resistant



Lockable Drawer

### T26



Multi-layer Storage Design



High-quality Material



Sturdy & Durable



Rust & Corrosion Resistant

Layered Storage Design: It includes designated layers for placing laptops, programming power supplies, diagnostic devices, and batteries.

Heavy-Duty Steel Construction: Forged from heavy duty steel, the cart exhibits strong resilience, lasting durability, and resistance to deformation.

Powder Coating Surface: The surface is treated with a powder coating, providing excellent rust and corrosion resistance.

360 ° Universal Casters: Made from natural rubber, the wheels ensure good noise reduction and minimize floor friction, allowing for easy movement.

Stainless Steel Handrails: The handrails are made from selected stainless steel materials, offering a smooth and shiny appearance that resists corrosion.

Model	T22	T23	T25	T26
Weight	23kg	23kg	27.5kg	27.5kg
Dimensions	44x74x100mm	44x74x100mm	44x74x100mm	44x74x100mm
Material	Cold Rolled Steel Plate			
Plate thickness	Bottom plate 3.0mm, Layers 1.5mm, Columns 1.5mm			
Load Capacity	≤300kg			





# ROLLING UTILITY CART



T22

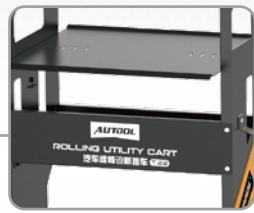

T23



T25



T26





T43

AUTOOL

62

# SERVICE TOOL STORAGE CABINET

AUTOOL's Service Tool Storage Cabinet is designed to help you organize your cluttered tools, optimize space utilization, and easily locate necessary items, thereby enhancing the tidiness of your workshop.



Multi-layer Storage Design



Sturdy & Durable



Rust & Corrosion Resistant



Strong Load-bearing Capacity

SERVICE TOOL STORAGE CABINET

T43



Tiered-storage Design



Pegboard Organizer

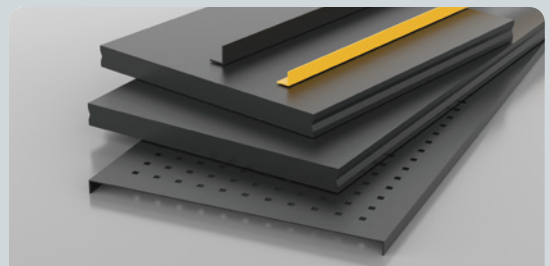

High-quality Material





Distributed by



📍 Unit 1303, Building 1, Runzhi R&D Center,  
Bao'an, Shenzhen, China  
✉ sales@autooltech.com  
🌐 www.autooltech.com  
☎ +86-755-23304822



📘 Autoool TECH



📺 Autoool TECH



🌐 www.autooltech.com

- Document not contractual.
- AUTOOL reserves the right to modify the specifications of the machines without prior notice.
- Printed on April 2025