

Copyright Information

Copyright © 2024 by SHENZHEN SMARTSAFE TECH CO.,LTD. All rights reserved. No part of this publication may be reproduced, stored in a retrieval system, or transmitted in any form or by any means, electronic, mechanical, photocopying, recording or otherwise, without the prior written permission of SMARTSAFE.

Neither SMARTSAFE nor its affiliates shall be liable to the purchaser of this unit or third parties for damages, losses, costs, or expenses incurred by purchaser or third parties as a result of: Accident, misuse, or abuse of this unit, or unauthorized modifications, repairs, or alterations to this unit, or failure to strictly comply with SMARTSAFE operating and maintenance instructions. SMARTSAFE shall not be liable for any damages or problems arising from the use of any options or any consumable products other than those designated as Original SMARTSAFE Products or SMARTSAFE Approved Products by SMARTSAFE.

All information, specifications and illustrations in this manual are based on the latest information available at the time of printing. SMARTSAFE reserves the right to make changes at any time without prior written or oral notice.

Trademark Information

SmartSafe is a registered trademark of SHENZHEN SMARTSAFE TECH CO.,LTD. in China and other countries. All other SMARTSAFE trademarks, service marks, domain names, logos, and company names referred to in this manual are either trademarks, registered trademarks, service marks, domain names, logos, company names of SMARTSAFE or are otherwise the property of SMARTSAFE or its affiliates. In countries where any of the SMARTSAFE trademarks, service marks, domain names, logos and company names are not registered, SMARTSAFE claims other rights associated with unregistered trademarks, service marks, domain names, logos, and company names. Other products or company names referred to in this manual may be trademarks of their respective owners. You may not use any trademark, service mark, domain name, logo, or company name of SMARTSAFE or any third party without permission from the owner of the applicable trademark, service mark, domain name, logo, or company name. You may contact SMARTSAFE by visiting the website at www.newsmartsafe.com, or writing to SHENZHEN SMARTSAFE TECH CO.,LTD., 3310, Building 11, Tianan Cloud Park, Bantian Street, Longgang District, Shenzhen, Guangdong, China, to request written permission to use Materials on this manual for purposes or for all other questions relating to this manual.

Contents

1. Product Overview	3
1.1 Product Features	3
1.2 Main Function and Test Range	3
1.3 System Components	3
1.4 Working Conditions	3
1.5 Environment & Energy Impact	3
2. Precautions for Safe Use	4
2.1 General Rule	4
2.2 Common Incorrect Operation	4
2.3 Damage Probably Caused By Incorrect Operation	4
2.4 Emergency Treatment In Exceptional Cases	4
2.5 Precautions In Exceptional Circumstances	4
2.6 Other Safety Alerts	4
3. Technical Features	4
4. Operating Instructions	6
4.1 Device interface and buttons	6
4.2 Connection Method	7
4.2.1 Cell Voltage Acquisition Wire and Battery Pack Connection	7
4.2.2 Working Power Supply Connecting	7
4.3 Main Unit Operation	7
4.3.1 Main Menu	8
4.3.2 Balancing	8
4.3.3 Record	11
4.3.4 Update	12
4.3.5 Settings	13
Warranty	16

1. Product Overview

EB240 is a EV battery cell equalizer developed by Smartsafe, mainly used to balance the voltage between cells of new energy vehicle battery packs with excessive voltage difference, so as to improve battery performance and extend the life of battery pack. This product mainly achieves independent balancing control for each connected battery cell, using low voltage and low current, and accurately configuring the connected battery cells to the same voltage level according to the voltage target set by the user.

1.1 Product Features

- Adopt the latest equalizing maintenance technology and avoid the interference to BMS (Battery Management System), EB240 is designed for lithium battery pack daily discharge, charge, and equalizing maintenance.
- Based on wide voltage range design, EB240 can be applied to lithium battery packs testing with various voltage levels.
- Voltage and temperature monitoring and protection during test can prevent over-charge and over-discharge.
- Multiple discharge auto-stop conditions make testing mode more intelligent and flexible, and avoid over-charge and over-discharge.
- Intelligent equalizing function based on each cell voltage monitoring and equalizing charge.
- Support equalizing maintenance parameter customization.
- Support multiple protection design and alarm settings of voltage, current, temperature abnormal to protect the battery and the balancer.
- Support functions such as overvoltage, undervoltage, overcurrent, output short circuit, anti-reverse protection and overheating protection.
- Adopt wave width modulation technology, high efficiency, high power factor, low noise, low electromagnetic interference.
- 10.1-inch touch screen, easy to operate.

1.2 Main Function and Test Range

Mainly used for lithium battery pack charge & discharge test and equalizing maintenance, suitable for various voltage levels.

1.3 System Components

The device consists of main unit and equalizing cables. The main unit includes color display screen, data processing unit, data monitoring unit, auxiliary power unit, power consuming unit, and panel operation unit.

1.4 Working Conditions

NO CORROSIVE, NO EXPLOSIVE, NO ELECTRICAL BREAKDOWN AIR OR CONDUCTIVE DUST.

1.5 Environment & Energy Impact

Placed in a dry storage room, temperature: -20°C ~ 70°C, humidity: 10% ~ 93%.

2. Precautions for Safe Use

2.1 General Rule

Please follow the user manual to use this balancer.

2.2 Common Incorrect Operation

- 1) Tools for connecting is not well insulated.
- 2) Operating without following the user manual.

2.3 Damage Probably Caused By Incorrect Operation

- 1) Short circuit accident: Tools is not well insulated, or battery pack positive and negative electrodes are too close.
- 2) Failure to follow the correct operation method will cause the device not working properly.

2.4 Emergency Treatment In Exceptional Cases

Disconnect the device power supply and test cables.

2.5 Precautions In Exceptional Circumstances

If the operator uses tools without well insulation or improper operate to cause short circuit, please separate the cables immediately.

2.6 Other Safety Alerts

Strict compliance with safety operating norms and correct operating procedure.

3. Technical Features

Function Parameter	
Model	EB240
Power input	AC 90~264V, 50/60Hz
Charging & discharging voltage range	1.8~4.2V
Voltage measurement accuracy	$\pm(0.1\%FS\pm 2mV)$
Charging & discharging current range	0.1~ 5A
Current measurement accuracy	$\pm(1\%FS\pm 0.05A)$
Battery temperature detection accuracy	$\pm 2^{\circ}C$ ($-25^{\circ}C$ -- $85^{\circ}C$) Charge and discharge temperature range is settable
Max channel quantity in	2 string x Max 12 cells

single unit	
Charging & discharging power	600W Max
Voltage & temperature test port	24Pin*2
Display	10.1-inch TFT LCD screen, resolution 1280*800
PC Data communication	TCP/IP , USB-Device
Wireless communication	Wi-Fi
Data transfer	Internal storage of device or data transfer to USB flash drive
Charging mode	Constant current charging + constant voltage charging
Discharge mode	Constant current (constant power, constant resistance discharge selectable)
Protection mechanism	Overcharge and over discharge protection Over voltage, over current, over temperature protection Battery short connection, reverse connection protection Abnormal protection against power cord and main cable failure Fan abnormal protection
Safety Testing	
Breaking down test	AC input-metal shell: 2200Vdc 1min
	DC input-metal shell: 2200Vdc 1min
Working Environment	
Cooling	Forced air cooling
Working Temperature	-5°C ~ 45°C
Working Humidity	5% ~ 93%
Size and Weight	
Dimension	500.5 x 337.8 x 445.7 mm

4. Operating Instructions

4.1 Device interface and buttons

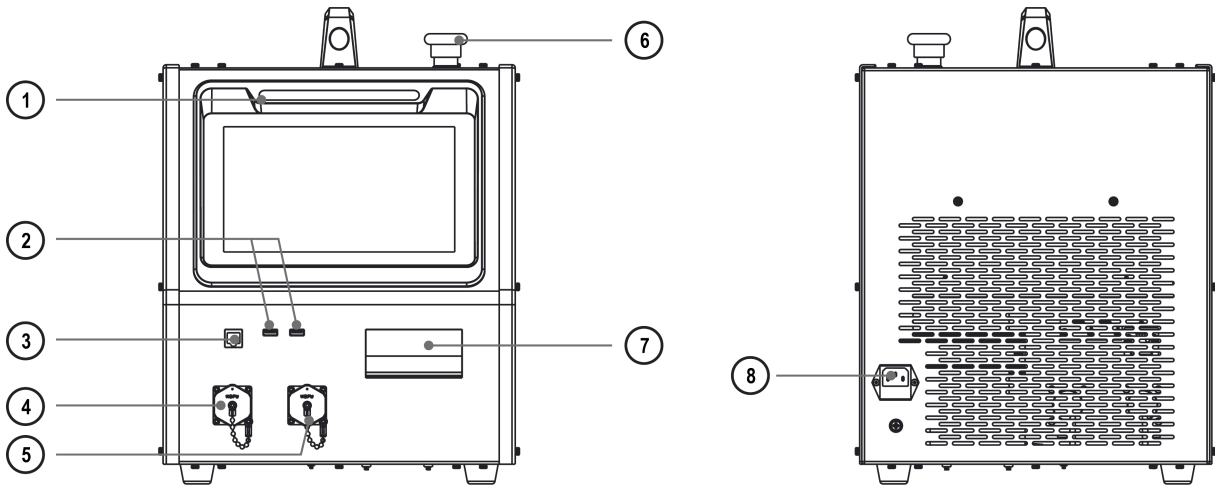

No.	Name	Description
1	Light strip	Green constant light indicates that the device is in standby mode; Blue constant light indicates work in progress; Yellow constant light indicates a non-stop warning; Red flashing indicates a fault/shutdown warning.
2	USB interface	Used to export data.
3	Communication interface	Used for communication and other expandable functions.
4	Channel 1 port	Connect to the channel 1 of the voltage and temperature measuring main cable.
5	Channel 2 port	Connect to the channel 2 of the voltage and temperature measuring main cable.
6	AC circuit breaker	Turn on/off the AC input.
7	Emergency stop switch	Used to cut off the power supply of the device in an emergency and stop the device immediately. After pressing this emergency stop switch button, the emergency stop switch must be turned to the right to reset it before the AC circuit breaker can be closed again.
8	Power socket	Connect the AC power cord.

4.2 Connection Method

- 1) Insert the aviation plug of the voltage & temperature measuring main cable into the Channel 1/Channel 2 port, and connect the other end to the cell voltage acquisition wire and temperature measuring cable.
- 2) Connect the cell voltage acquisition wire and temperature measuring cable to the cell being tested.
- 3) Insert the power cord into the power input port of main unit, and connect the other end to the power source.

Note: Please make sure to turn off the power of the device before connecting the voltage & temperature measuring main cable to avoid damage to the device.

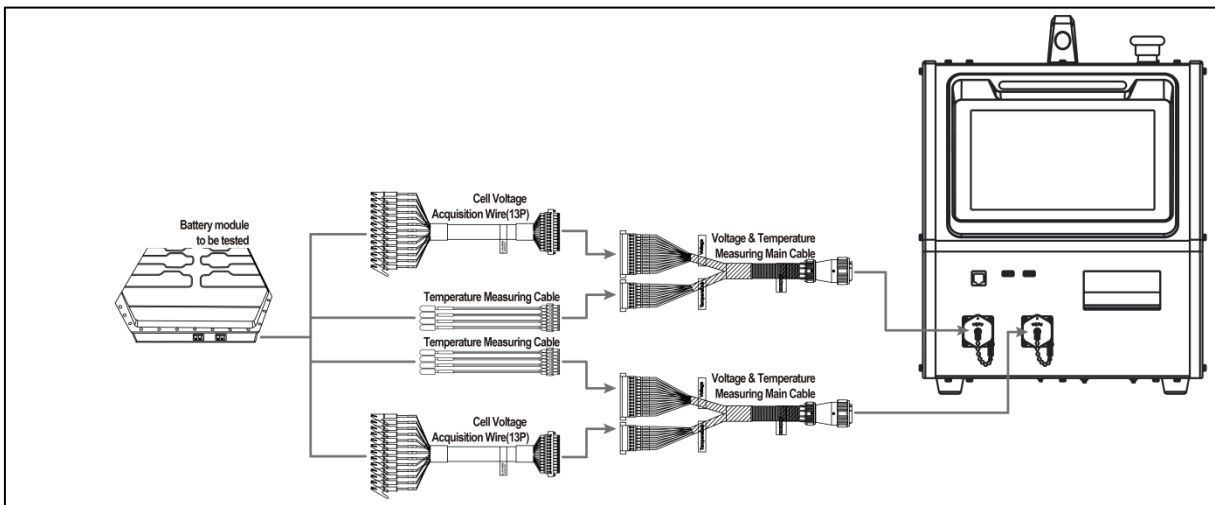

4.2.1 Cell Voltage Acquisition Wire and Battery Pack Connection

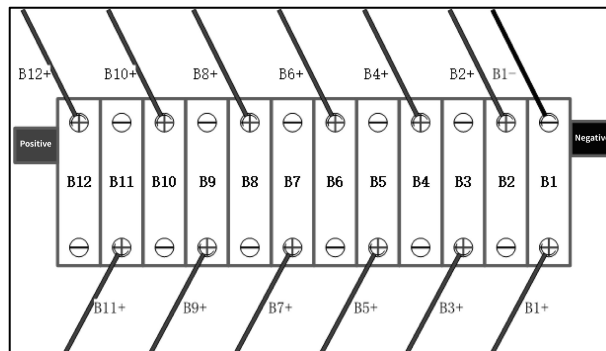

According to the wire label on the cell voltage acquisition wire, B1 - is connected to the negative electrode of No. 1 cell (B1), B1 + is connected to the positive electrode of No. 1 cell (B1), B2 + is connected to the positive electrode of No. 2 cell (B2), and connected in sequence.

Note: the nearest to the negative terminal of the battery module is the No. 1 cell.

4.2.2 Working Power Supply Connecting

Connect the power supply cord with the main unit power socket, and please ensure AC power supply can support Single phase 90~264V AC Max 10Amp output.

4.3 Main Unit Operation

After the device is connected, close the AC circuit breaker and turn on the device.

4.3.1 Main Menu

After the device is turned on, it enters the balancing interface by default. Users can click the function module icon on the left side of the screen to switch to different function module interfaces. The function modules on the left include **Balancing**, **Record**, **Update** and **Settings**.

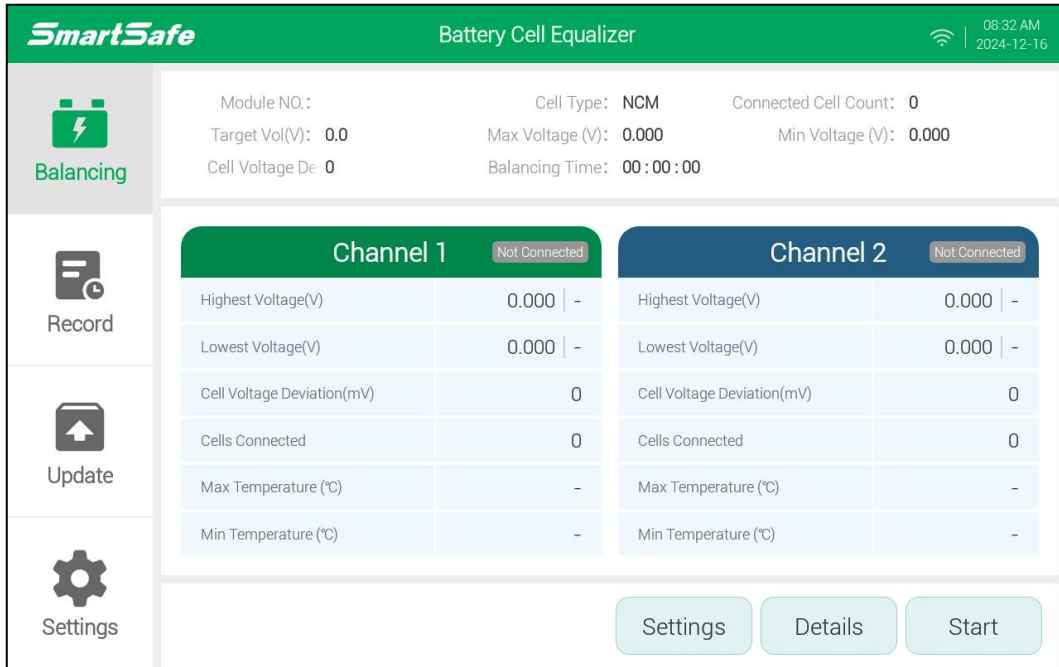

4.3.2 Balancing

1) In the balancing interface, click **Settings** to preset the balancing test parameters.

Module NO.:	<input type="text"/>	Cell Type	NCM
<small>Enter the module Name</small>			
Nominal Capacity	<input type="text"/> kWh	Connected Cell Count	2
		<small>Enter 1 ~ 24</small>	
Target Voltage	<input type="text"/> V	Balancing Initial Current	5.0 A
<small>Enter 3.0 ~ 4.2</small>		<small>Enter 0.05 ~ 5.0</small>	
Terminate Current	<input type="text"/> A		
		<input type="button" value="Back"/> <input type="button" value="Confirm"/>	

Name	Description
Module NO.	Battery module number.
Cell Type	Select the type according to the battery to be tested, supporting ternary lithium batteries, lithium titanate batteries, lithium manganese batteries and lithium iron phosphate batteries.

Nominal Capacity	The nominal capacity of the battery pack, according to the actual input, can be identified from the rating plate.
Connected Cell Count	Number of cells in series, according to the actual number of battery strings contained in the connected battery pack module.
Target Voltage	Cell balancing target voltage value.
Balancing Initial Current	The balancing initial current value.
Terminate Current	Current threshold for terminating balancing.

The parameter settings interface defaults to normal mode. To enter expert mode to set more parameter items, you can click on the **Settings** function module on the left side of the screen to enter the system settings interface. Click on **Expert Mode** in the system settings interface and then enter the parameter setting interface.

The following parameters can only be set in Expert Mode.

Name	Description
Battery Temperature Warning Threshold	Temperature threshold for battery cell over-temperature protection.
Terminate Cable Voltage Drop	Cable voltage drop threshold used to terminate balancing.
Alarm Cable Voltage Drop	Cable voltage drop threshold for alarming .
Adjusting Times	Set the balancing cycles to achieve more precise cell balancing, range 0~9, with 0 representing infinite cycles.
Over-charging/Over-discharging Protect Voltage	Battery over-charging/over-discharging protection voltage threshold.
Data Save Interval	The interval time for automatic data storage.

2) After setting the parameters, click **Confirm** to save the current settings and return to the balance interface. Click **Start** on the balance interface to start balancing.

Module NO.:	#1	Cell Type:	NCM	Connected Cell Count:	2
Target Vol(V):	3.1	Max Voltage (V):	3.799	Min Voltage (V):	3.798
Deviation(mV):	1	Balancing Time:	00:00:05		

Channel 1 Balancing		Channel 2 Not Connected	
Highest Voltage(V)	3.799 B02	Highest Voltage(V)	0.000 -
Lowest Voltage(V)	3.798 B01	Lowest Voltage(V)	0.000 -
Cell Voltage Deviation(mV)	1	Cell Voltage Deviation(mV)	0
Cells Connected	2	Cells Connected	0
Max Temperature (°C)	21.1	Max Temperature (°C)	-
Min Temperature (°C)	20.7	Min Temperature (°C)	-

Details Stop

3) During the balancing process, you can check the test progress and wait for the test results. Click **Stop** to end the current balancing process.

Module NO.:	#1	Cell Type:	NCM	Connected Cell Count:	2
Target Vol(V):	3.1	Max Voltage (V):	3.799	Min Voltage (V):	3.798
Deviation(mV):	1	Balancing Time:	00:00:00		

Channel 1 Standby		Channel 2 Standby	
Highest Voltage(V)	3.799 B02	Highest Voltage(V)	0.000 -
Lowest Voltage(V)	3.798 B01	Lowest Voltage(V)	0.000 -
Cell Voltage Deviation(mV)	1	Cell Voltage Deviation(mV)	0
Cells Connected	2	Cells Connected	0
Max Temperature (°C)	21.2	Max Temperature (°C)	-
Min Temperature (°C)	20.6	Min Temperature (°C)	-

Settings Details Start

4) Click **Details** to view the specific data of the tested battery, including balancing time, cell voltage, cell balancing current, charge and discharge capacity, and temperature of each temperature monitoring point.

The screenshot shows a monitoring interface with a top bar containing a timer (00:00:21), a 'Voltage' tab, a 'Temperature' tab, and a refresh icon. Below the tabs are two columns: 'Channel 1' and 'Channel 2'. Each column has a table with columns for Voltage (V), Amperage (A), and Amp-hours (Ah). Channel 1 shows data for B1 and B2, while Channel 2 shows dashes for all cells from B1 to B12.

Channel 1				Channel 2			
	V	A	Ah		V	A	Ah
B1	3.798	3.649	-0.008	B1	-	-	-
B2	3.799	3.651	-0.008	B2	-	-	-
B3	-	-	-	B3	-	-	-
B4	-	-	-	B4	-	-	-
B5	-	-	-	B5	-	-	-
B6	-	-	-	B6	-	-	-
B7	-	-	-	B7	-	-	-
B8	-	-	-	B8	-	-	-
B9	-	-	-	B9	-	-	-
B10	-	-	-	B10	-	-	-
B11	-	-	-	B11	-	-	-
B12	-	-	-	B12	-	-	-

4.3.3 Record

1) Click on **Record** in the left function menu to enter the record interface.

The screenshot shows the 'Record' interface. At the top, there is a search bar with the text 'Please enter Module NO., Time, or CellType to search' and a 'Search' button. Below the search bar is a table with columns: No., Module NO., Time, Cell Type, and Operation. The table contains 8 records. At the bottom, there is a 'Total 115 Records' label and four navigation buttons: 'First Page', 'Previous Page', 'Next Page', and 'Last Page'. On the left side, there is a vertical menu with icons for 'Balancing', 'Record' (highlighted), 'Update', and 'Settings'.

No.	Module NO.	Time	Cell Type	Operation
1	#1	December 16, 2024 08:33:45	NCM	Details Delete
2	#1	December 16, 2024 08:30:29	NCM	Details Delete
3	test	December 16, 2024 01:52:04	NCM	Details Delete
4	gh	December 14, 2024 07:47:04	NCM	Details Delete
5	rrty	December 13, 2024 07:28:47	LFP	Details Delete
6	rrty	December 13, 2024 07:10:21	NCM	Details Delete
7	rrty	December 13, 2024 07:09:21	NCM	Details Delete
8	rrty	December 13, 2024 07:08:43	NCM	Details Delete

2) Click the **Delete** button on the right side of an individual record or click the **Delete** button on the record details page to remove the record from the list.

3) Click the **Detail** button on the right side of an individual record to view the record details.

Note: By entering keywords in the top search bar, you can quickly find the corresponding record.

Module Information		
Module NO. : #1	Cell Type: NCM	
Number of Cells: 2	Balancing Time: 00 : 00 : 34	
Target Vol(V): 3.1V	Lowest Limited Voltage: 3.0V	
Initial Balancing Current: 5.0A	Terminate Current: 0.05A	
Initial Deviation of Cell Voltage: 1mV	Ended Deviation of Cell Voltage: 1mV	
Nominal Capacity: 0.0kWh	Battery Temperature Warning Threshold: 0.0°C	

Overall Balancing Results		
Cell Type:	Before Balancing	After Balancing
Highest Cell Voltage (V)	3.799(PA2)	3.799(PA2)
Lowest Cell Voltage (V)	3.798(PA1)	3.798(PA1)
Deviation of Cell Voltage (mV)	1	1
Highest Temperature (°C)	21.1	21.0
Lowest Temperature (°C)	21.1	21.0

Delete Print Export PDF Export Excel Back

4) On the individual record details page, click the **Print** button to print the record.

5) Insert the USB memory stick, click the **Export PDF** or **Export Excel** button on the individual record details page, and you can export the record to the USB memory stick.

4.3.4 Update

Click **Update** in the function menu on the left to enter the software Update interface. Select options such as **APP Upgrade**, **Firmware Upgrade** or **System Upgrade** to view the current version and the latest version, and click **Update Now** to upgrade the APP, firmware or system to the latest version.

Note: To perform software update functions, it is necessary to connect to a wireless network firstly; To ensure the normal update, please ensure network stability during the update process.

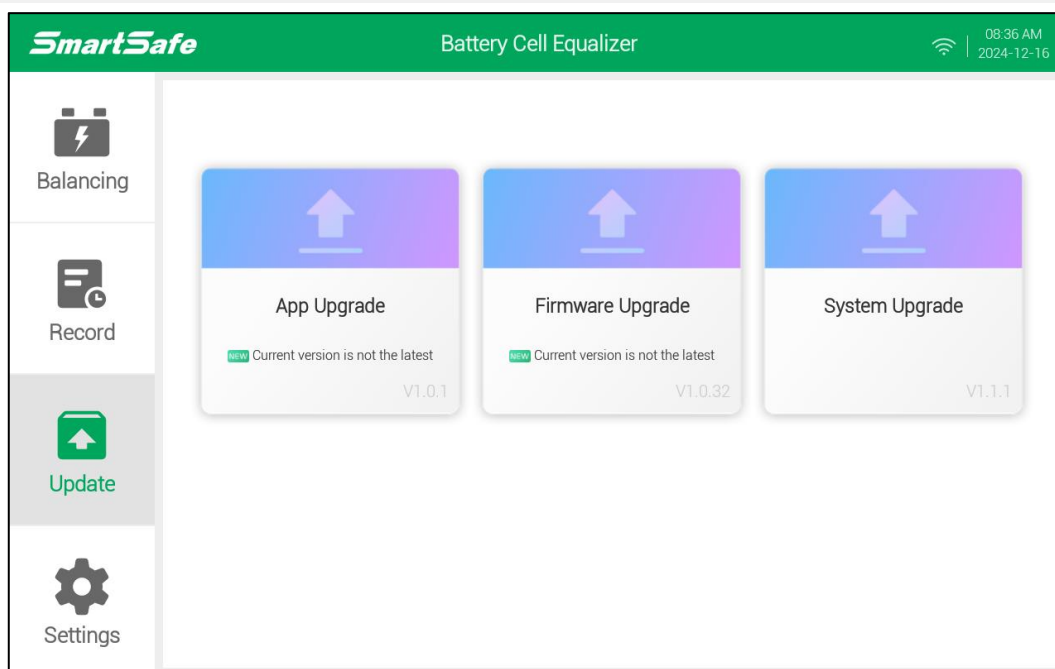

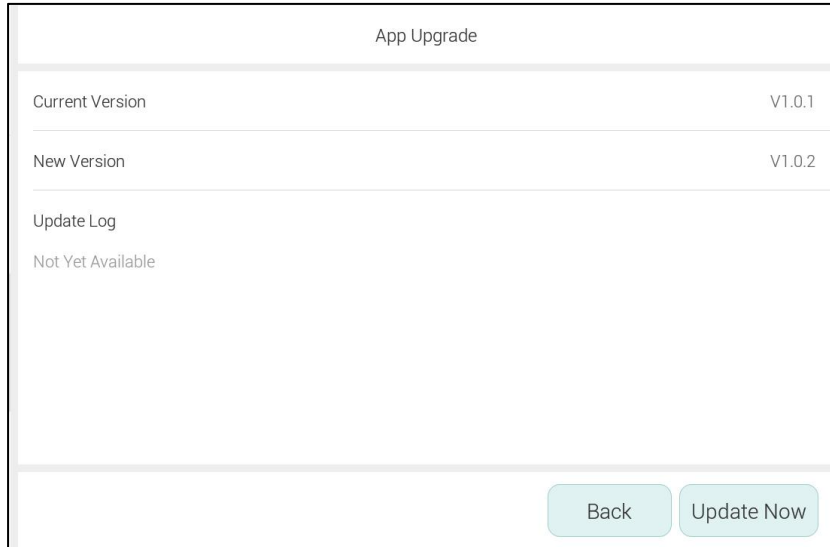

4.3.5 Settings

Click **Settings** in the function menu on the left to enter the system settings interface. The system settings include **WLAN**, **Language**, **Date and Time**, **Expert Mode**, **Developer Mode**, **Device Self Check** and **About**.

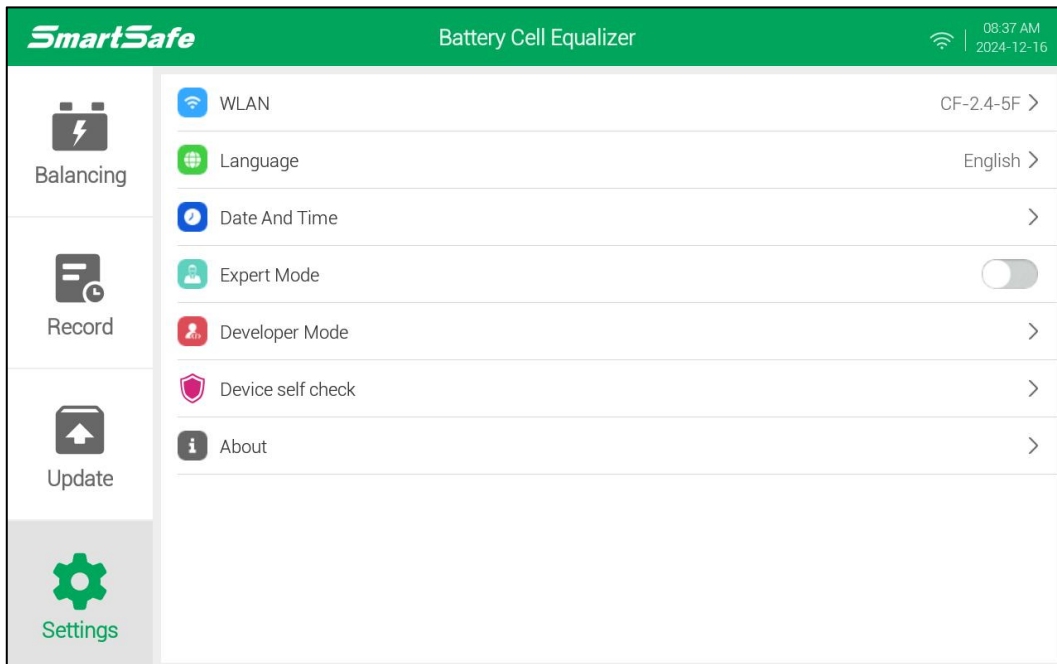

WLAN: Used to set up the device's wireless network connection.

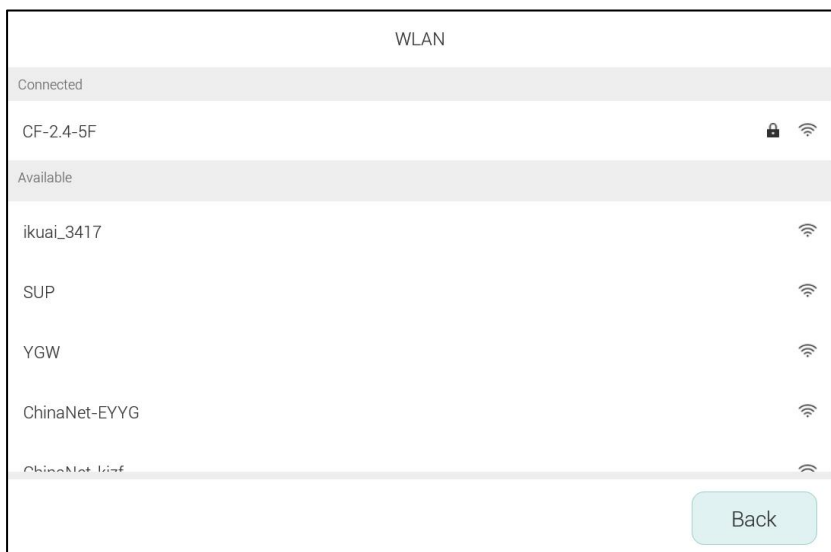

Language: Used to set the system language.

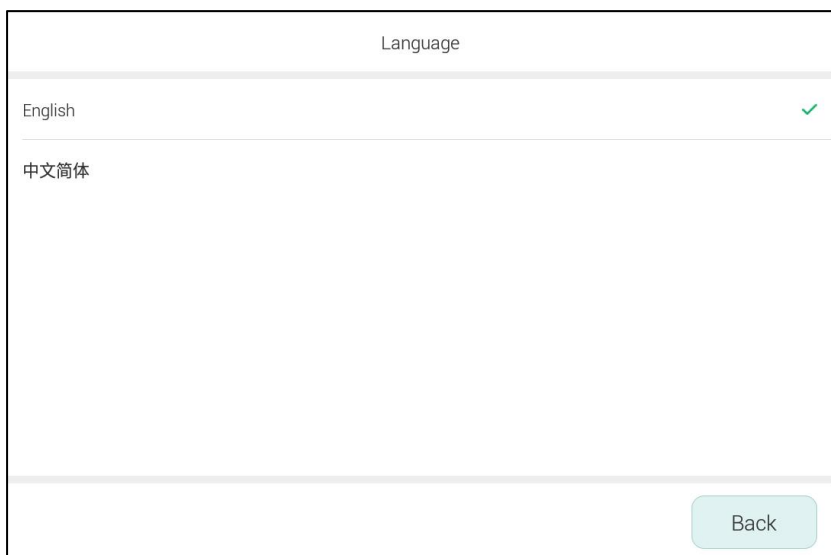

Date and time: Used to set date, time and time zone, etc.



Expert mode: Used to switch the parameter setting mode of charging and discharging to Expert mode.

Developer Mode: This function is only for development and maintenance, a password is required.

Device self-test: Support automatic self-check of device.

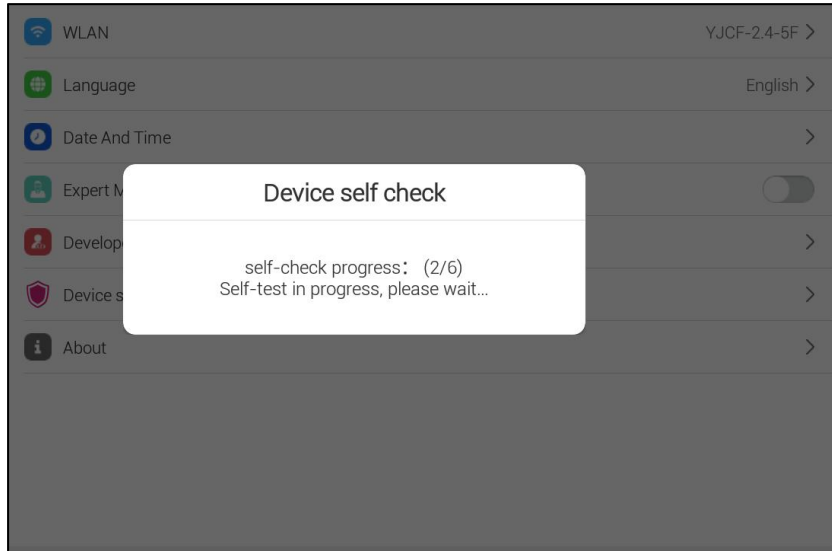

About: Used to view information such as Device Model, APP Version, Firmware Version, System Version and Device Serial Number.

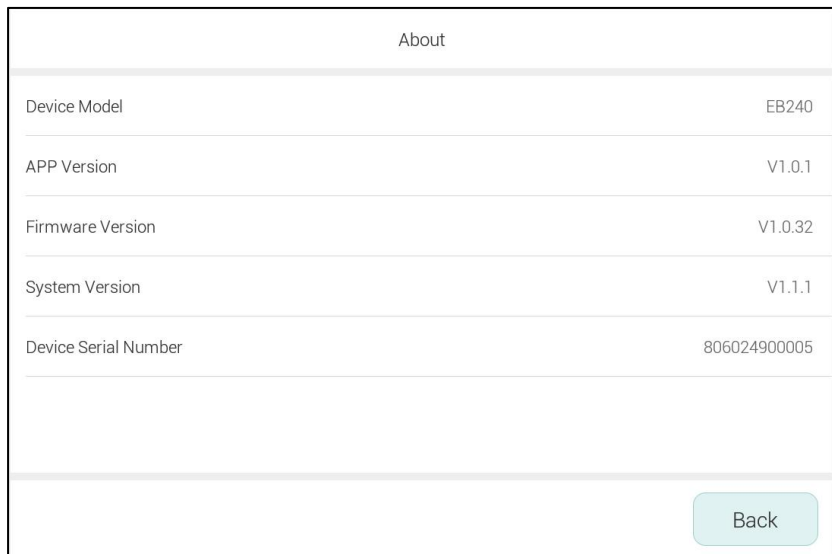

Warranty

THIS WARRANTY IS EXPRESSLY LIMITED TO PERSONS WHO PURCHASE SMARTSAFE PRODUCTS FOR PURPOSES OF RESALE OR USE IN THE ORDINARY COURSE OF THE BUYER'S BUSINESS.

SMARTSAFE electronic product is warranted against defects in materials and workmanship for one year from date of delivery to the user.

This warranty does not cover any part that has been abused, altered, used for a purpose other than for which it was intended, or used in a manner inconsistent with instructions regarding use. The exclusive remedy for any automotive meter found to be defective is repair or replacement, and SMARTSAFE shall not be liable for any consequential or incidental damages.

Final determination of defects shall be made by SMARTSAFE in accordance with procedures established by SMARTSAFE. No agent, employee, or representative of SMARTSAFE has any authority to bind SMARTSAFE to any affirmation, representation, or warranty concerning SMARTSAFE automotive meters, except as stated herein.

Disclaimer

The above warranty is in lieu of any other warranty, expressed or implied, including any warranty of merchantability or fitness for a particular purpose.

Purchase Order

Replaceable and optional parts can be ordered directly from your SMARTSAFE authorized dealer. Your order should include the following information:

- Order quantity
- Part number
- Part name

Statement:

SMARTSAFE reserves the rights to make any change to product designs and specifications without notice. The actual object may differ a little from the descriptions in the manual in physical appearance, color and configuration. We have tried our best to make the descriptions and illustrations in the manual as accurate as possible, and defects are inevitable, if you have any question, please contact local dealer or after-sale service center of SMARTSAFE, SMARTSAFE does not bear any responsibility arising from misunderstandings.